



GROUP OF COMPANIES

**D&POS**

BUSINESS AND STABILITY

# PRODUCT CATALOG

# CONTENTS

- 04** ABOUT THE COMPANY
- 06** HISTORY
- 20** VERSATILE SUPPLIER OF METAL PRODUCTS
- 30** MANUFACTURING
- 32** PROCESSING OF REINFORCED STEEL
  - 34 WELDED MESH
  - 38 FASTENERS FOR WELDED MESH
  - 40 FITTINGS AND WIRE
  - 44 FRAMES OF BORED PILES
  - 48 WELDED MECH IN ROLLS
  - 50 TACKER AND BENDING PRODUCTS
- 52** PROCESSING OF FLAT-ROLLED PRODUCTS
  - 54 SLITTING OF COILED STILL
  - 58 CROSSCUTTING OF COILED STEEL
  - 62 PROFILED GRATING
  - 68 EXPANDED STEEL SHEET
  - 70 TUBULARS
  - 76 STRUCTURAL SHAPES
  - 80 REINFORCED PROFILES
  - 84 MOUNTING PROFILES
  - 86 FINISHING PROFILES
  - 90 ROLL-FORMED CHANNEL
  - 92 FULL CUT EXTENDED MESH
- 94** GRATING
  - 96 WELDED GRATINGS
  - 102 PRESSED GRATING
  - 106 CUT PROFILED GRATING
  - 110 STAIRS
- 116** SERVICES
  - 118 PROTECTIVE COVERING
  - 122 PHYSICAL AND MECHANICAL TESTS
  - 124 LASER CUTTING
  - 126 PLASMA ARC CUTTING
  - 128 SHEET PUNCHING
  - 132 METAL FORMING
  - 134 ENGINEERING CENTER
  - 136 DELIVERY
  - 138 SCRAP RECYCLING
- 140** OUR PROJECTS
- 142** CONTACTS

# ABOUT THE COMPANY

**THE GROUP OF COMPANIES "D&POS"** is a production and commercial organization with a high level of service and its own production for the processing of reinforcing steel, flat rolled products and the manufacture of gratings.

The production complexes of "D&POS" are equipped with equipment from leading world brands. Quality control and certification of manufactured products comply with modern standards.

The enterprise processes more than 350 thousand tons of rolled metal annually. We supply steel products in Russia and the CIS countries. The branches of the company are situated in 5 regions of the Russian Federation.

Delivery of products is carried out by SCANIA heavy trucks equipped with a satellite navigation system, which allows you to control the time of delivery of products to the customer. There is also possibility to deliver products by rail and to form combined orders.

Since 2007, our company has been regularly honored with the awards "Best SMC in Russia" and "Best steel and metal warehouse in Russia".



OUR MOTTO -  
**BUSINESS  
AND STABILITY!**



OWN FLEET OF  
VEHICLES OF  
**120 SCANIA VEHICLES**

**OVER 2000 NAMES**  
OF PRODUCTS  
IN PORTFOLIO

STORAGE  
ROOMS -  
**OVER 50 HA**

**MORE THAN 60 UNITS**  
OF MODERN  
EQUIPMENT

PRODUCTIVE  
CAPACITY -  
**60 000 TONS PER MONTH**

RAW MATERIALS  
PROCESSING -  
**1 500 TONS PER DAY**

BRANCHES OF THE GROUP OF  
COMPANIES -  
**IN 5 FEDERAL DISTRICTS**

MORE THAN 1 200  
SPECIALISTS  
**INVOLVED IN MANUFACTURING**





# HISTORY

**1992** - YEAR OF FOUNDATION OF LLC "PCF "D&POS"

**1995** "D&POS" received the title of the official supplier of Moscow Construction Department.

**1997** Opening of the main warehouse complex in Lytkarino.

**1999** Joining the Russian Association of Metal Traders, which unites the largest producers and sellers of metal in Russia.  
In the rating of metal trading companies of Russia, LLC "PCF" "D&POS" was recognised as the best supplier of rolled steel and one of the leading versatile suppliers in the country.  
On July 14, the SmolMetTorg branch was opened.

**2000** The geography of rolled metal supplies is expanding. Deliveries cover: Smolensk, Kirov, Tula, Lipetsk and Ryazan regions, Krasnodar Krai, North-West region, as well as regions of Siberia and the Far East.  
On March 9, the branch "Vyatsky SMC" in Kirov was opened, and on August 21 - "D&POS-Altay" in Barnaul.



**D&POS IS ALL OVER RUSSIA!**



**2001** The starting point of the company's activity is the supply of rolled metal to the construction complex of Moscow:

- ◇ Buildings of Sberbank of Russia,
- ◇ The Cathedral of Christ the Saviour,
- ◇ Moscow Ring Road,
- ◇ Second transport ring,
- ◇ Shopping center on Manezhnaya square,
- ◇ Moscow International Business Center "Moscow City",
- ◇ RC "Alye Parusa"

AND OTHER OBJECTS OF HOUSING AND SOCIAL CONSTRUCTION.

On May 30, a branch of the company "D&POS" was opened in Novomoskovsk - "DiMETA", and on July 12 - a branch in the northern capital - "D&POS-St. Petersburg".

**2003** – "VERKHNEVOLZHSKY SMC" BEGINS TO OPERATE IN IVANOV

The SMC's activity area is the production, processing and sale of rolled metal products. Supplies of metal and metal products cover Ivanovo, Kostroma, Yaroslavl, Vladimir and Nizhny Novgorod regions.

**2004** The manufacturing of welded mesh was launched. The group of companies "D&POS" was awarded with the cup "For the best exposition" at the Metal-Expo 2004 exhibition. According to the results of the competitions "Best steel and metal warehouse of Russia-2004" and "Best SMC in Russia - 2004", the winners in the corresponding nominations were the steel and metal warehouse of "D&POS" in Lytkarino and "Verknevolzhsky SMC" in Ivanovo.

Since this year, the branches of the group of companies "D&POS" have been annually awarded with honorary awards of this competition.





## 2005

The volume of sales increased by 5 %, and the output of own products increased by 5 times - up to 10 000 tons per month. Quality certificates for welded meshes were obtained. The group of companies "D&POS" mastered the manufacturing of tacker and bending elements. Two new metal processing lines were put into operation: an Italian one for slitting rolled steel and an Austrian one for cold rolled reinforcing steel.

## 2006

The group of companies "D&POS" put into operation a high-performance correctly cutting machine. "D&POS" is the winner of the competition "Partnership - 2006" established by PJSC Severstal, in the nomination "Breakthrough of the Year".

In September 2006, a laboratory was organized to certify cold-deformed reinforcement of our own production and meshes from it.





## **2007** - A NEW PRODUCTION BUILDING FOR PROCESSING ROLLED STEEL WAS PUT INTO OPERATION AT THE VERKHNEVOLZHISKY SMC

Up-to-date high-tech equipment was purchased in Spain, Italy, Germany for slitting and transversal cutting of metal and manufacturing of profiles.

There was a presentation and launch of a unique Spanish line of transversal cutting of metal, which allows to produce bars of rectangular, rhombic, trapezoidal and triangular shapes.

For the input control of incoming raw materials, a line of testing laboratory equipment from Zwick/Roell (Germany) was purchased.

"D&POS" presented new technologies for construction: fasteners for meshes (spacer strips), which are manufactured with the help of the automatic equipment of Austrian production

"Verkhnevolzhsky SMC" got the compliance certificate of the Quality Management System with the requirements of GOST R ISO 9001:2000.

German travelling cranes with a lifting capacity of 10 and 20 tons were put into operation.

**The products of own production of the company "D&POS" were replenished with profiles of its own production: construction, reinforcing and mounting rail. LLC "PCF" "D&POS" took 129th place in the annual rating of 200 largest private companies by Forbes magazine**





## **2008** – A NEW PRODUCTION COMPLEX FOR PROCESSING OF REINFORCED STEEL OPENED IN LYTKARINO

Presentation of a new sheet metal processing workshop on the territory of "Verkhnevolzhsky SMC". Following the general concept of development of the group of companies "D&POS" for the period 2007-2015, in July, the company "D&POS" successfully launched a rolled metal processing complex based on the territory of "Verkhnevolzhsky SMC". The first delivery of parent sheets for testing die tooling for the manufacture of auto components was made to Japan and China. Commissioning of an automatic German line for the production of an expanded steel sheet with various parameters and shapes of mesh was carried out.



**2009** In order to optimize production at "Verkhnevolzhsky SMC", a major overhaul was carried out and the automatic line of slitting was transferred to the production building for sheet metal processing.

Another, more powerful testing machine was put into operation, as well as a blanking die for the production of samples in accordance with EN 10002-1 and a special machine of the same company for grinding cut samples. In the same year, LLC "Verkhnevolzhsky SMC" was recognised as a potential supplier for the production of Renault cars after a successful the successful completion of a technical audit by ALFA Automotive Technologies by the department for ensuring the supply of profiled body elements.



**2010** At the beginning of the year, two laser processing machines with a capacity of 2 kW and 3 kW were installed and put into operation.

Instruments and equipment for testing paint and varnish and metal coatings were purchased and mastered.

In 2010, two branches were opened in Altai Krai: June 1 - "D&POS-Aleysk", on October 27 - "D&POS-Rubtsovsk".

**2011** The company "D&POS" offered an innovative solution in the production and application of finishing profiles, starting to produce finishing profiles using a unique technology.

**2012** Construction of a covered warehouse complex with an area of 20,000 sq. m in Lytkarino. "D&POS" started using a universal rail vehicle for transportation - the Hercules truck. In May 2012, a slitting line with a thickness of 1-7. 0 mm was put into operation at "Verkhnevolzhsky SMC".





**2012**

In October 2012, the installation of a pipe welding mill with an average capacity of 25 thousand tons per year was completed and a preproduction lot of shaped tubes was manufactured.

"D&POS" received the status of a strategic partner of JSC "Ural Pipe Plant".

THE GROUP OF COMPANIES "D&POS" INCREASES  
SALES OF METAL PRODUCTS AND **IS IN THE TOP THREE  
OF THE LARGEST METAL TRADERS OF THE COUNTRY**

**2013**

A collection of Standards of the Organization has been released, which has become an indispensable assistant for design and construction organizations, as well as for specialists of construction inspections.

Three lines of transversal cutting of rolled steel produced in Italy, South Korea and Russia were launched at "Verkhnevolzhsky SMC".





THE PRODUCTION OF WELDED GRATING **WAS LAUNCHED** USING **THE NEWEST AUSTRIAN EQUIPMENT**

## 2014

In March 2014, a new mesh-welding line was put into operation at the production enterprise "D&POS-Kuban".

A new workshop for the production of welded meshes started its work at "Verkhnevolzhsky SMC". On the eve of the Metallurgist Day in Ivanovo, a working visit of representatives of PJSC Severstal took place at the "Verkhnevolzhsky SMC".

The organizing committee of the Metal-Expo 2014 exhibition awarded "D&POS" representatives with commemorative gold medals for special merit. The management of "D&POS" took part in the meeting of the club of business partners of the metallurgical corporation "EVRAZ" at the Moscow School of Management "Skolkovo". This event allowed "D&POS" to strengthen its partner ties with "EVRAZ", one of the world leaders in metallurgy.

**IN JUNE 2014, THERE WAS A 10 YEARS ANNIVERSARY OF THE PARTNERSHIP OF "D&POS" AND THE AUSTRIAN COMPANY EVG, MANUFACTURER OF MACHINES FOR MANUFACTURING METAL PRODUCTS.**





## **2015** - "D&POS" IS THE LARGEST MANUFACTURER OF WELDED GRATINGS IN RUSSIA

Construction of iconic facilities of Moscow, in which "D&POS" participated: Moskvarium, the building of the shopping centers "Aviapark" and "June" in Mytischy, the Volvo and Lafarge plants in Kaluga and the Bridgestone tire plant in Ulyanovsk. "D&POS" received gratitude from PJSC Severstal for increasing the share of product purchases.



## **2016** - "D&POS" WAS RECOGNIZED AS THE BEST SALES NETWORK FOR ITS QUALITY OF CUSTOMER SERVICE

This award was another confirmation of the recognition of reliable partnerships, growth and an excellent reputation in the industry market.

The products of "Verkhnevolzhsky SMC" entered in the top 100 products of Russia. Welded grating was awarded with the diploma "Novelty of the Year".

"D&POS" confirmed its status as a platinum partner of the holding "EVRAZ".

The company set a record for the shipment of rolled metal products. During the day, 2 650 tons of products were sold.

**"D&POS" started production of welded mesh of economy class**



## 2017 – OUR OWN TOOL AND MACHINE WORKSHOP WAS OPENED

for overhaul and modernization of production lines, manufacturing of spare parts and non-standard equipment for all branches of the group of companies "D&POS".

A new line of laser cut of metal was launched.

An international carrier license was obtained. The geography of metal supplies was expanded.

The branch "D&POS-Krasnodar" opened on April 4.



## 2018 – "VERKHNEVOLZHSKY SMC" IS 15 YEARS OLD

"D&POS" took part in the exhibition "Metal Structures - 2018". The types of innovative products made of welded gratings, as well as the manufacturing of pipes, roll-formed channel, laser cutting and plasma arc services, metal bending services were demonstrated at its mount.

The branch "D&POS-Rostov" opened on March 12.



## 2019 – "VERKHNEVOLZHISKY SMC" TOOK PART IN THE NATIONAL PROJECT "IMPROVING LABOR PRODUCTIVITY"

"D&POS" took part in the exhibitions: "ChechenSroyExpo" and "Metal structures - 2019".

The certificate of the Russian Register of Shipping on the standard approval of the welded gratings, that were manufactured by us, was received.

**A workshop on manufacturing of gratings was opened at "Verkhnevolzhsky SMC"**

New lines were launched:

- ♦ of manufacturing of welded gratings and its framing;
- ♦ of manufacturing of pressed grating;
- ♦ of slitting and transversal cutting of the rolled steel;
- ♦ as well as the service of cutting metal on a coordinate punch press.





**2020**

Hot galvanizing of products was launched. A new section of the laboratory was created, specialized equipment for mechanical testing of grating was purchased.

The technology of powder polymer coating of products was mastered.

Alexander Ivanovich Drozdov became the General Director of "Verkhnevolzhsky SMC".

A NEW ADMINISTRATIVE AND AMENITY BUILDING  
WAS BUILT AT "VERKHNEVOLZHISKY SMC"

**2021**

A new service, welding of wheel arches for cars of European brands produced at factories in Russia, was launched at "Verkhnevolzhsky SMC".

New services were added to the profile of the company: bending and zinc-coating of welded meshes. Research on the use of passive exoskeletons in production was launched.

**2022 — "D&POS" IS 30 YEARS OLD!**







GROUP OF COMPANIES

**D&POS**

BUSINESS AND STABILITY





# VERSATILE SUPPLIER OF METAL PRODUCTS



"D&POS" has been selling rolled metal products since its foundation and is actually one of the pioneers of metal trading in Russia. Today, "D&POS" is one of the largest metal trading companies, and its leadership is ensured both by the scale of trading operations and the number of transactions, and by knowledge of all the subtleties of the market.

Over the years, not only the country's largest steel and metal warehouse and a powerful dealer infrastructure have been created, but also a rich experience of trading activities has been accumulated, strong relationships with suppliers have been built, unique methods of interaction with consumers have been developed. All of this allows the company to deal with tasks of the highest level of complexity and meet the needs of the most demanding client.



The trading division of the company is an analogue of a supermarket that can work with both private clients and large wholesale customers with equal success. Such versatility is reached due to a wide range of the offered products. At the warehouses of "D&POS", there are always more than 2000 names of products - rolled and flat rolled steel, pipes, metal products of our own production.

The variety of goods is provided by the fine alignment of relations with manufacturers, including the largest metallurgical plants in Russia, as well as some representatives of this industry in the near abroad.

The relationship with the client is built in such a way as to ensure the longterm partnership in the future. Therefore, along with the breadth of the choice of products offered, much attention is paid to the quality of service.

## OUR SUPPLIERS

- ◇ SEVERSTAL;
- ◇ NOVOLIPETSK METALLURGICAL PLANT;
- ◇ MAGNITOGORSK METALLURGICAL PLANT;
- ◇ EVRAZ
- ◇ MECHEL;
- ◇ METINVEST;
- ◇ BELORUSSIAN METALLURGICAL PLANT.



SERVICE QUALITY STANDARDS IN OUR COMPANY ARE BASED ON TWO KEY COMPONENTS - **EFFICIENCY AND RELIABILITY**. THE CLIENT'S EFFORTS ARE REDUCED TO A MINIMUM, AND **THE ENTIRE MENTAL LOAD**, BOTH LITERALLY AND FIGURATIVELY, **IS TAKEN BY "D&POS"**



# THE WHOLE RANGE OF ROLLED METAL PRODUCTS

## ROLLED STEEL

- ◇ FITTING;
- ◇ REINFORCING CAGE;
- ◇ BEAM;
- ◇ SQUARE;
- ◇ CIRCLE;
- ◇ STRIP;
- ◇ WELDED MESH;
- ◇ WELDED MECH IN ROLLS;
- ◇ TACKER AND BENDING PRODUCTS;
- ◇ ANGLE;
- ◇ FASTENER;
- ◇ FULL CUT EXTENDED MESH;
- ◇ CHANNEL;
- ◇ HEXAGON.

## PROFILE ROLLED STEEL

- ◇ PROFILED GRATING;
- ◇ EXPANDED STEEL SHEET;
- ◇ REINFORCEMENT PROFILE;
- ◇ MOUNTING PROFILE;
- ◇ FINISHING PROFILE;
- ◇ BUILDING PROFILE;
- ◇ STRIP (SCELP);
- ◇ SHEET (HOT-ROLLED, COLD-ROLLED, COLOURED, ZINKED);
- ◇ CHECKER PLATE;
- ◇ PERFORATED SHEET.

## GRATINGS

- ◇ WELDED GRATINGS;
- ◇ PRESSED GRATING;
- ◇ CUT PROFILED GRATING;
- ◇ FASTENER;
- ◇ PROTECTIVE COVERING.

## PIPE PRODUCTS

- ◇ PROFILE PIPES;
- ◇ SMALL AND MEDIUM PIPES;
- ◇ LARGE PIPES.

## METAL GOODS

- ◇ WIRE;
- ◇ ELECTRODES.

OUR HEAD OFFICE IS LOCATED **IN THE VERY CENTER OF MOSCOW**. EXPERIENCED MANAGERS NOT ONLY HAVE INFORMATION ABOUT THE AVAILABILITY OF GOODS IN WAREHOUSES AND THE PRICE, BUT ALSO CAN GIVE **PROFESSIONAL ADVICE** ON ANY ISSUES RELATED TO THE PROPERTIES OF METAL PRODUCTS, ITS TRANSPORTATION AND APPLICATION.











GROUP OF COMPANIES

# D&POS

BUSINESS AND STABILITY







The company's office and warehouse complex work in a single mode. After processing the order, the manager transmits the information via a single computer network to the company's warehouse, where the metal is prepared for shipment to the client. The warehouses work round the clock, without weekends and holidays. For efficient customer service, documents for the shipment of products are drawn up directly at the warehouse. The method of payment does not matter - it can be either non-cash or cash.

The warehouse complex in the Moscow region is situated in Lytkarino. The large area of the complex (20 ha), on the one hand, allows to always have a wide range of products available, and on the other hand, provides the opportunity to load goods from several sites at once. Several hundred cars can be loaded here per day. The steel and metal warehouse is equipped with a modern crane equipment with a lifting capacity of 10-20 tons.

In order to efficiently solve the problems of logistics and identification of metal products, a unified corporate system of packaging and labeling has been developed. The weight of the shipped products is determined using high-precision electronic scales. Moreover, the specialists of the company carry out a constant input and output control of products, which guarantees the high quality of the products purchased by the client. The warehouse complex in Lytkarion has repeatedly won the competition "The Best Steel and Metal Warehouse in Russia".

IN ADDITION TO MOTOR TRANSPORT, "D&POS" OFFERS **DELIVERY BY RAIL**, PROVIDES A COMPLETE SET OF **PREFABRICATED CARS** AND **DIRECT DELIVERIES** FROM METALLURGICAL PLANTS

One of the most important components of the trading activity of "D&POS" is its transport functionality. Approximately 50% of the products purchased by customers are delivered to their destination by the company's own vehicles.

Today, the fleet of "D&POS" consists of more than 100 heavy duty trucks SCANIA. All of them are equipped with a mobile positioning system, which monitors the location of each vehicle on the way and the time of delivery of metal products.

A multi-ton transaction will seem to it no heavier than a sheet of paper. By and large, its participation is necessary only when drawing up and signing a supply contract. You do not even need to have a pen with yourself - we will be happy to give to a client as a gift in any of our offices.







ИСКУССТВО ПРОИЗВОДСТВА

The image shows a large industrial factory interior. A prominent orange banner with white Cyrillic text "ИСКУССТВО ПРОИЗВОДСТВА" (Art of Production) is suspended across the upper part of the frame. Below the banner, a long, silver, corrugated metal duct runs horizontally. In the foreground and middle ground, there are several industrial machines, including a large white robotic arm or assembly station with a metal safety railing. The floor is a smooth, light-colored concrete. In the background, more machinery and structural elements of the factory are visible, including a yellow crane hook hanging from the ceiling.



WE IMPLEMENT  
**MODERN TECHNOLOGIES**  
OF **PRODUCTION** USING  
EQUIPMENT BY THE WORLD'S  
BEST BRANDS





# MANUFACTURING



The steel service centers of our group of companies have modern production facilities for the manufacturing of their own products from rolled metal for construction, automotive, machine-building, fuel and energy and other industries.

All manufactured products are accompanied by their own quality certificate.

The raw materials from which we manufacture products are supplied directly from large metallurgical plants.

WE STRIVE TO PRODUCE **HIGH-QUALITY METAL PRODUCTS ON TIME** AND ACCORDING TO THE SPECIAL REQUIREMENTS OF OUR CUSTOMERS



OUR **MANUFACTURING SECTOR** INCLUDES  
THREE **AREAS:**



**PROCESSING  
OF  
REINFORCED  
STEEL**



**PROCESSING  
OF FLAT-  
ROLLED  
PRODUCTS**

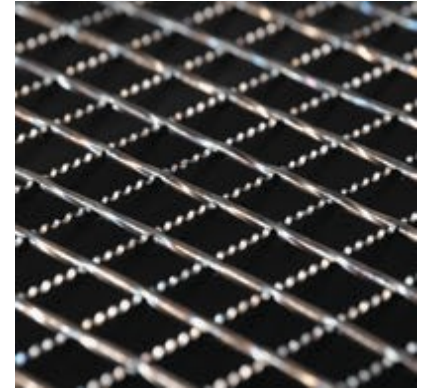

**MANUFACTURING  
OF GRATING**

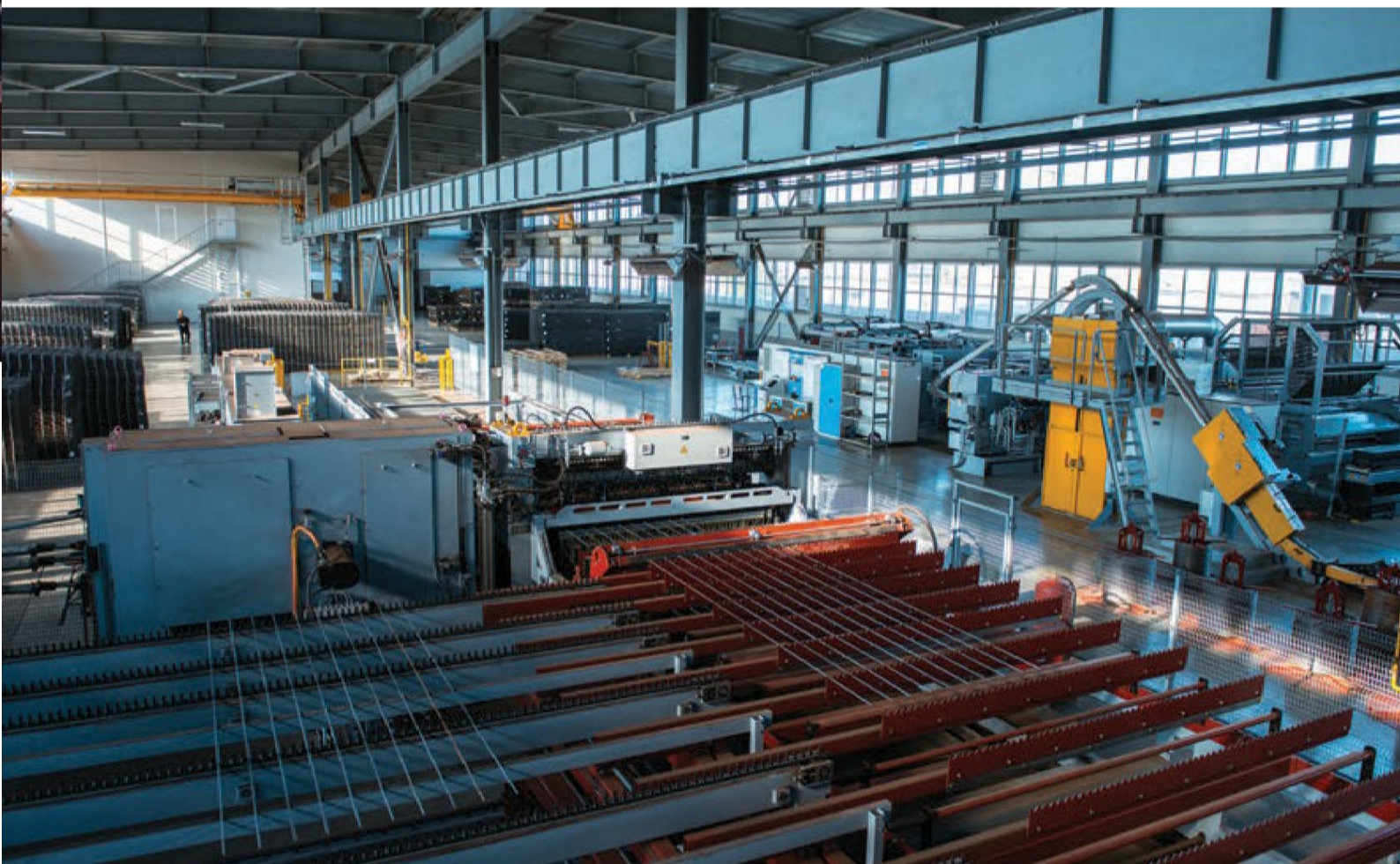



The background of the entire page is a close-up photograph of reinforced steel. In the foreground, several parallel steel bars with a ribbed texture run diagonally from the bottom left towards the top right. Behind them, there are stacks of steel mesh, with some sections wrapped in blue plastic. The lighting is dramatic, highlighting the metallic sheen and the texture of the steel.

# PROCESSING OF **REINFORCED** STEEL

- ◇ WELDED MESH
- ◇ FASTENERS FOR WELDED MESH
- ◇ FITTINGS AND WIRE
- ◇ FRAMES OF BORED PILES
- ◇ WELDED MESH IN ROLLS
- ◇ TACKER AND BENDING PRODUCTS







# WELDED MESH



THE GROUP OF COMPANIES "D&POS" IS ONE OF THE LARGEST MANUFACTURERS OF STEEL WELDED MESH

**WELDED MESH** IS A PRODUCT THAT IS MADE OF REINFORCED STEEL BY WELDING AT THE PLACES OF INTERSECTION OF LONGITUDINAL AND TRANSVERSE RODS, WITH THE LOCATION OF THE RODS IN TWO MUTUALLY PERPENDICULAR DIRECTIONS.

## OUR PRODUCTS

- ◇ PROVIDES SIGNIFICANT INCREASE IN PRODUCTIVITY;
- ◇ REDUCES LABOR COSTS AND THE ESTIMATED COST OF WORK BY 2-3 TIMES;
- ◇ DOES NOT HAVE WASTE DUE TO THE POSSIBILITY OF USING THE MESH OF NON-STANDARD SIZES.

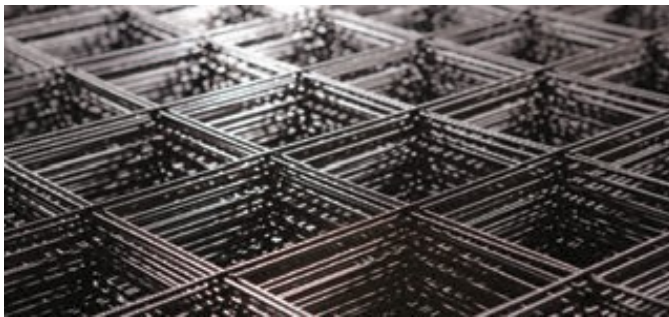

## SCOPE OF APPLICATION

- ◇ MANUFACTURING OF REINFORCED CONCRETE STRUCTURES;
- ◇ CONSTRUCTION AND OPERATION OF BUILDINGS AND STRUCTURES;
- ◇ MANUFACTURING OF CAGES FOR BIRDS AND ANIMALS;
- ◇ FILLING IN CONCRETE;
- ◇ INSTALLATION OF SCREEDS OF FLOORS, FOUNDATIONS AND COVERINGS;
- ◇ PLASTERING;
- ◇ REINFORCEMENT OF BRICKWORK;
- ◇ BRIDGE CONSTRUCTION;
- ◇ ROAD CONSTRUCTION;
- ◇ MANUFACTURING OF STACKS;
- ◇ MODERN ERGONOMIC HEDGES, ETC



# PRODUCTION CAPABILITIES

**MAIN CLASSES OF REINFORCED STEEL FOR MANUFACTURING OF WELDED MESHES:** Bp-1; B500C, A500C, A600C, A400, A240 according to GOST R 52544, GOST 34028, GOST 6727 and other classes of reinforcement that meet the requirements of standards and specifications, as well as design documentation for reinforced concrete structures and products. It is allowed to use a wire made according to other regulatory documents, including those developed by the manufacturer.

## LEGEND

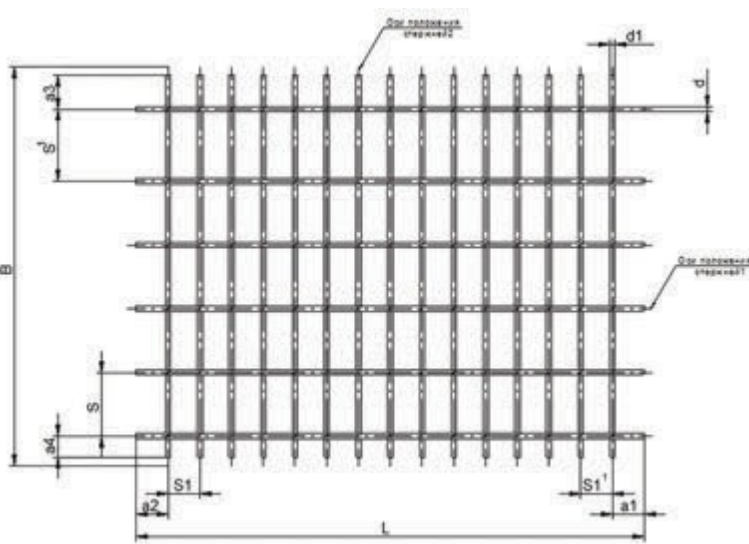

- ◇ rod pitch (S and S1) and additional rod pitch (S1 and S11) in millimeters;
- ◇ diameter (d and d1) and class of rod;
- ◇ mesh width (B) in millimeters;
- ◇ mesh length (L) in millimeters;
- ◇ for meshes with the dimensions of the outlets of longitudinal rods (a1 and a2) and transverse rods (a3 and a4) that differ from 25 mm, the mark of mesh after the designation of the mesh length is supplemented with:  $(a1+a2)/(a3+a4)$ , where a1, a2, a3 and a4 are the dimensions of the outlets in millimeters (if  $a1=a2$ ,  $a3=a4$ , one value is given in the denominator).

NAME	SPECIFICATIONS
Mesh width B	60 – 2 750 mm
Mesh length L	from 60 to 12 000 mm (the rolls' length is up to 200 m)
The pitch of the transverse rods S1	25 – 3000 mm
The pitch of the longitudinal rods S	25 – 500 mm
Longitudinal outlets a1 and a2	15 – 2000 mm
Longitudinal outlets a3 and a4	0 – 1000 mm
Maximum weight of mesh packs	3 tons (standard weight)
Packs' height	up to 800 mm
Diameters of longitudinal and transverse rods	from 1.6 mm to 16 mm inclusively
Cells	from 25x25 mm and further smooth regulation with a pitch of 1 mm

Contact **welding** in accordance with GOST-14098 at the nodes of intersection of the wire, type of welded joint K1 - Kt. Welded mesh is supplied in rolls or cards.

# ADVANTAGES OF WORKING WITH "D&POS"

- ◇ our products are manufactured using high-precision modern Austrian equipment;
- ◇ the possibility to manufacture mesh of non-standard sizes at the request of the customer;
- ◇ development of drawings of non-standard meshes for coordination with the customer;
- ◇ the meshes are certified in the Mosstroy certification system in compliance with GOST 23279 and GOST R 57997, and are also tested in our own laboratory. It is possible to manufacture in accordance with the requirements of other regulatory documentation;
- ◇ products in stock and on order;
- ◇ we manufacture construction, masonry, industrial, fencing, anti-digging and road mesh of economy class.





# FASTENERS FOR WELDED MESH



**THE FASTENER** SERVES FOR SEPARATION OF THE LOWER LAYER OF REINFORCEMENT FROM THE UPPER ONE BY THE DESIGN DISTANCE (THE LOWER AND UPPER BELT OF THE REINFORCED MESH IS MADE OF REINFORCEMENT OR WELDED MESH).

# ADVANTAGES OF OUR PRODUCTS

- ◇ reduction of labor intensity of reinforcement works;
- ◇ light weight of the product;
- ◇ fixation with greater stability, strength and reliability;
- ◇ the ability to more accurately withstand the design dimensions of reinforcement works;
- ◇ triangle (the toughest figure) lies in the basis of our fastener;
- ◇ delivery of finished products allows you to save the area of the production site;



- ◇ the products are made in full compliance with the requirements of the normative and technical documentation;
- ◇ the possibility of manufacturing direct fasteners and "snakes";
- ◇ in stock and on order;
- ◇ possibility of delivery of any volume;
- ◇ high-quality products manufactured on modern Austrian equipment using our own manufacturing technology.

## PRODUCTION CAPABILITIES

NAME	SPECIFICATIONS
Height of the fastener, H	40 - 200 mm (depending on the protective layers, the diameter of the reinforcement and the height of the product (floor slab, concrete floor, etc.))
Diameter of load-bearing rod, d1	3 – 5 mm
Diameter of zig-zag rod, d2	3 – 5 mm
Pitch of the snake, l	Multiple 150 mm
Length of bent fastener, L	2 000 mm

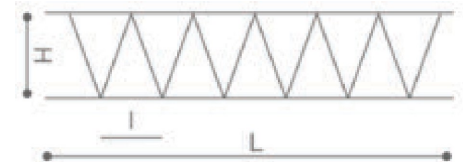

## SCOPE OF APPLICATION

- ◇ ROAD SLABS;
- ◇ MANUFACTURING OF ASSEMBLED REINFORCED CONCRETE STRUCTURES;
- ◇ MONOLITHIC CONSTRUCTION;
- ◇ MONOLITH-CONCRETE FLOORS.



# FITTINGS AND WIRE





## DELIVERY FORM - **RODS AND COILS.**

### FITTINGS AND WIRES IN COILS

NAME	PARAMETERS
Diameter of fittings	From 3.0 to 12.0 mm
Inner diameter of coil	400 – 900 mm
Outer diameter of coil	800 – 1 250 mm
Height of coil	600 – 2 000 mm
Weight of coil	800 – 3 000 kg



### FITTINGS IN RODS

NAME	PARAMETERS
Diameter of fittings	From 6.0 to 40.0 mm
Standard length of rods	6 and 11.7 m



By agreement, it is possible to manufacture and supply fittings of other sizes on an individual order.

## TYPES OF PRODUCTS

We offer hot-rolled, cold-rolled fitting and wire of smooth and periodic profile according to:

- ◇ GOST R 52544,
- ◇ GOST 34028,
- ◇ GOST 5781,
- ◇ GOST 6727,
- ◇ GOST 3282,

as well as according to TR, IS and other regulatory documents.



# OUR PRODUCTS

- ◇ HAVE THREE-SIDED CORRUGATION PROFILE;
- ◇ PROVIDE 20% METAL SAVINGS IN COMPARISON WITH OTHER TYPES OF FITTINGS;
- ◇ REDUCE COSTS FOR CONSTRUCTION PROJECTS;
- ◇ ENSURE THE CONTINUITY OF THE MANUFACTURING PROCESS OF CONSTRUCTION REINFORCEMENT ELEMENTS FROM ROLLED PRODUCTS OF THE B500C CLASS, AS A RESULT OF WHICH A SIGNIFICANT REDUCTION IN ELECTRICITY AND LABOR COSTS IS ACHIEVED.



NAME	SPECIFICATIONS
Diameter of fittings	6, 7, 8, 9, 10 mm
Inner diameter of coil	610 – 620 mm
Outer diameter of coil	850 – 1 100 mm
Height of coil	850 mm
Weight of coil	1 000 – 3 000 mm
Length of the rod	Any on order, 12 m maximum

## OUR ADVANTAGES

- ◇ products from the largest suppliers (PJSC "Severstal", PJSC "NLMK", LLC "AEMZ", SUE "LPZ") and of our own production;
- ◇ possibility of delivery of any volume;
- ◇ fittings of standard sizes, as well as on a special order;
- ◇ increased structural capabilities;
- ◇ available prices.



## SCOPE OF APPLICATION

- ◇ MANUFACTURING OF REINFORCED MESH;
- ◇ REINFORCEMENT OF REINFORCED CONCRETE STRUCTURES, REINFORCEMENT FRAMES, INCLUDING IN WESTERN EUROPEAN COUNTRIES ACCORDING TO DIN 488;
- ◇ MANUFACTURING OF EMBEDMENTS FOR CONCRETE;
- ◇ MANUFACTURING OF TACKER AND BENDING PRODUCTS (HOOKS, ANCHORS, HINGES, EMBEDMENTS) ETC;
- ◇ MANUFACTURING OF REINFORCED CONCRETE STRUCTURES;
- ◇ CONSTRUCTION AND OPERATION OF BUILDINGS AND STRUCTURES;
- ◇ BRIDGE CONSTRUCTION;
- ◇ FUEL AND ENERGY COMPLEX ETC



# FRAMES OF BORED PILES



**REINFORCEMENT FRAMES** ARE FLAT AND THREE-DIMENSIONAL STRUCTURES MADE BY WELDING OR RIGID BINDING WITH KNITTING WIRE FROM A VARIETY OF REINFORCEMENT OR WIRE INTENDED FOR THE INSTALLATION OF REINFORCED CONCRETE PRODUCTS.



## OUR PRODUCTS

- ◇ ensure low noise of the process of building construction, which allows work to be carried out near residential buildings;
- ◇ used for the construction of buildings of any purpose: residential, public or industrial type structures;
- ◇ used on almost all soils, except for large-block and rocky ones;
- ◇ have a high bearing capacity, which allows the use of piles under heavy loads;
- ◇ can have any diameter, which will allow it to work better under horizontal load;
- ◇ minimize the amount of waste during construction;
- ◇ reduce terms and cost of construction.

REINFORCEMENT FRAMES ARE **OMNI-PURPOSE**, THEY SUIT FOR THE CONSTRUCTION OF VARIOUS TYPES OF BUILDINGS, **REGARDLESS OF THEIR PURPOSE**. ESPECIALLY OFTEN THE TECHNOLOGY IS USED WHEN IT IS NECESSARY TO BUILD A HOUSE OR A PRODUCTION FACILITY **NEXT TO THE ALREADY CONSTRUCTED BUILDINGS**.





# SCOPE OF APPLICATION

- ◇ CONSTRUCTION AND OPERATION OF BUILDINGS AND STRUCTURES;
- ◇ BRIDGE CONSTRUCTION;
- ◇ CONSTRUCTION OF FACILITIES NEAR WATER BODIES, ON UNEVEN TERRAIN AND SLOPES.



BORED PILES HAVE BECOME POPULAR SINCE THE EARLY 90S AND HAVE GREATLY REDUCED THE PERCENTAGE OF USE OF PRECAST REINFORCED CONCRETE PILES OF PRELIMINARY READINESS.

NUMEROUS ACCIDENTS AND DAMAGE TO SURROUNDING BUILDINGS WHEN DRIVING TRADITIONAL REINFORCED CONCRETE PILES AT DISTANCES OF UP TO 20 METERS FORCED DESIGNERS AND BUILDERS TO INTRODUCE NEW TECHNOLOGIES THAT HAVE A MORE SPARING IMPACT ON THE SURROUNDING BUILDINGS.



# PRODUCTION CAPABILITIES

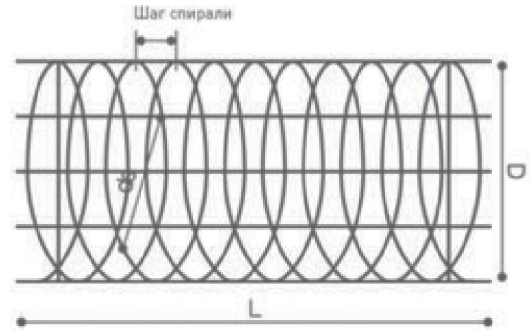

NAME	SPECIFICATIONS
Cross-section diameter of the frame	no limitations
Lead of a helix	no limitations
Maximum length of the frame	up to 23 500 mm
Maximum weight of the frame	up to 12 500 kg
Cross-section diameter of the longitudinal reinforcement	no limitations
Cross-section diameter of the spiral reinforcement	no limitations

## OUR ADVANTAGES

- ◆ our products are made from rolled metal that is tested in our own laboratory;
- ◆ making an order according to individual parameters of any complexity;
- ◆ minimum order execution time, due to the constant availability of rolled metal on the production site;
- ◆ using modern technologies, we produce high quality reinforcement cages with reliable connections.





# WELDED MECH IN ROLLS



**WELDED MECH IN ROLLS** IS MANUFACTURED OF THERMALLY UNTREATED GALVANIZED OR NON-GALVANIZED WIRE WITH A DIAMETER OF 1.2 TO 3 MM. MANUFACTURING IS CARRIED OUT BY THE METHOD OF LAYING STEEL THREADS PERPENDICULARLY TO EACH OTHER. TO CONNECT INDIVIDUAL WIRES INTO A STRONG MESH, THE POINTS OF THEIR INTERSECTION ARE WELDED. FOR THIS PURPOSE, AUTOMATED EQUIPMENT IS USED TO ENSURE THE ACCURACY OF THE WORK.



NAME	SPECIFICATIONS
Raw material	Thermally untreated light galvanized and non-galvanized wire
The used diameters of wire	from 1.2 mm to 3.0 mm
Sizes of cells	12,5x12,5 mm, 12,5x25 mm, 12,5x50 mm, 25x25 mm, 25x50 mm, 50x50 mm — standard sizes. It is also possible to produce meshes with cells up to 100 mm in multiples of 12.5 mm. The output wires are cut at 0 mm.
The width of rolls	150, 200, 250, 300, 350, 500, 1 000, 1 500, 1 800, 2 000 mm — standard. It is also possible to manufacture rolls with a width of 100 to 2,000 mm in multiples of the cell sizes.
The length of rolls	Standard - 25 m or 50 m. It is also possible to manufacture rolls with a length of 5 to 100 m.
Outer diameter	For rolls with a winding of 25 m — from 310 to 430 mm, for rolls with a winding of 50 m — from 370 to 500 mm. The diameter of the roll depends on the thickness of the wire, the size of the cell and the line on which the rolls are manufactured.

## SCOPE OF APPLICATION

THE WELDED MESH IN ROLLS HAS A LOW WEIGHT WITH A HIGH SPECIFIC STRENGTH, AS WELL AS A SIGNIFICANT SERVICE LIFE OF MORE THAN 25 YEARS.

THESE PROPERTIES ALLOW IT TO BE USED FOR VARIOUS PURPOSES:

- ◇ CONSTRUCTION OF FENCES, CAGES AND CRATES;
- ◇ SEPARATION OF LAND PLOTS;
- ◇ APPLYING PLASTER IN A THICK LAYER;
- ◇ REINFORCEMENT OF THE STRAPPING OF HEATING MAINS;
- ◇ REINFORCEMENT IN THE CONSTRUCTION OF WALLS (AS A MASONRY);
- ◇ CLOSING OF VENTILATION DUCTS AND HATCHES.

MOREOVER, IT IS WIDELY USED TO PROTECT FRUIT TREES FROM GNAWING ANIMALS.

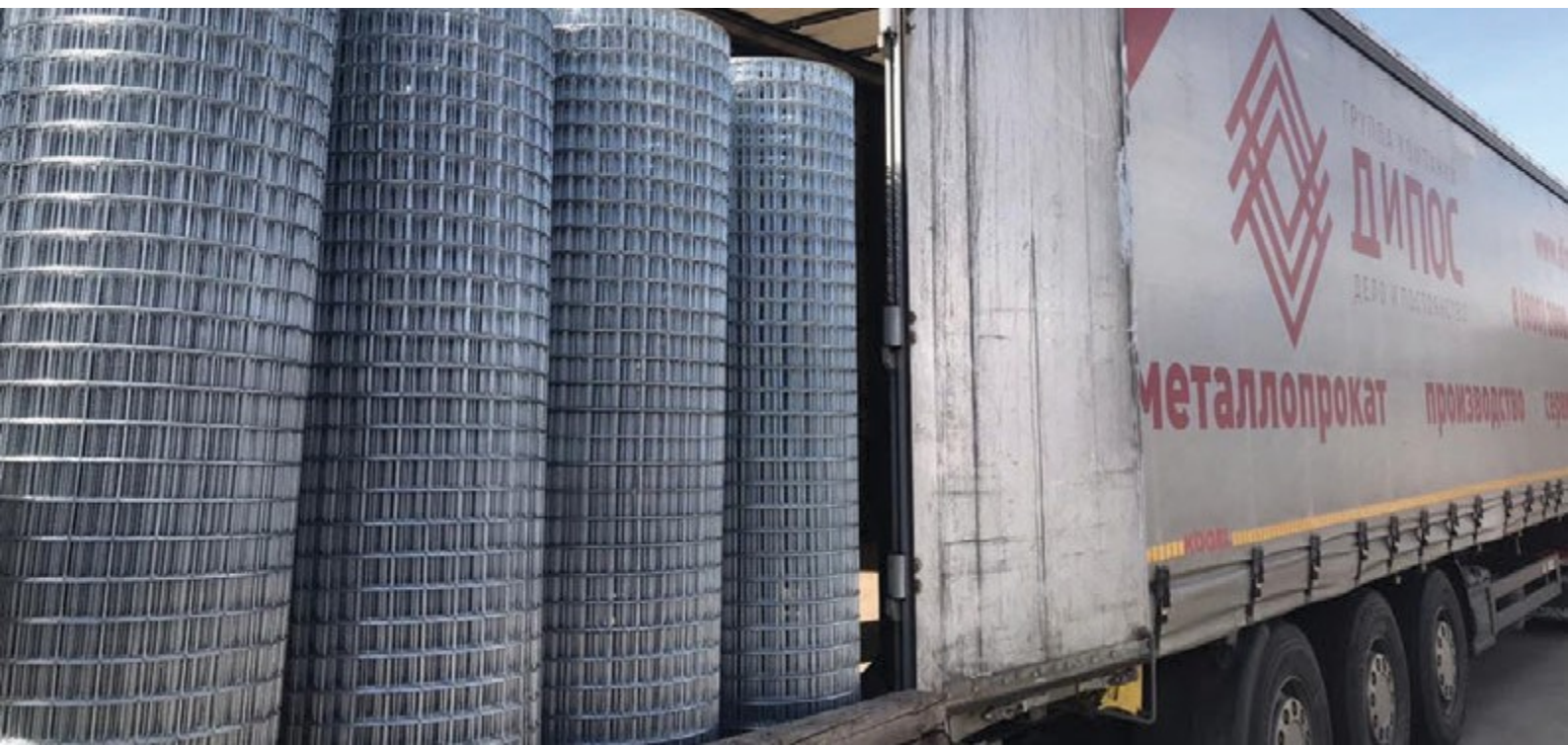



# TACKER AND BENDING PRODUCTS

THE GROUP OF COMPANIES "D&POS" MANUFACTURES TACKER AND BENDING PRODUCTS - A HIGH-QUALITY AND PROFESSIONAL CORRECTION OF THE BAY REINFORCEMENT WITH SUBSEQUENT CUTTING TO THE DESIRED SIZE:

- ◇ LOOPS;
- ◇ ANCHORS;
- ◇ CLAMPS;
- ◇ OTHER EMBEDDED PART OF COMPLICATED FORMS.

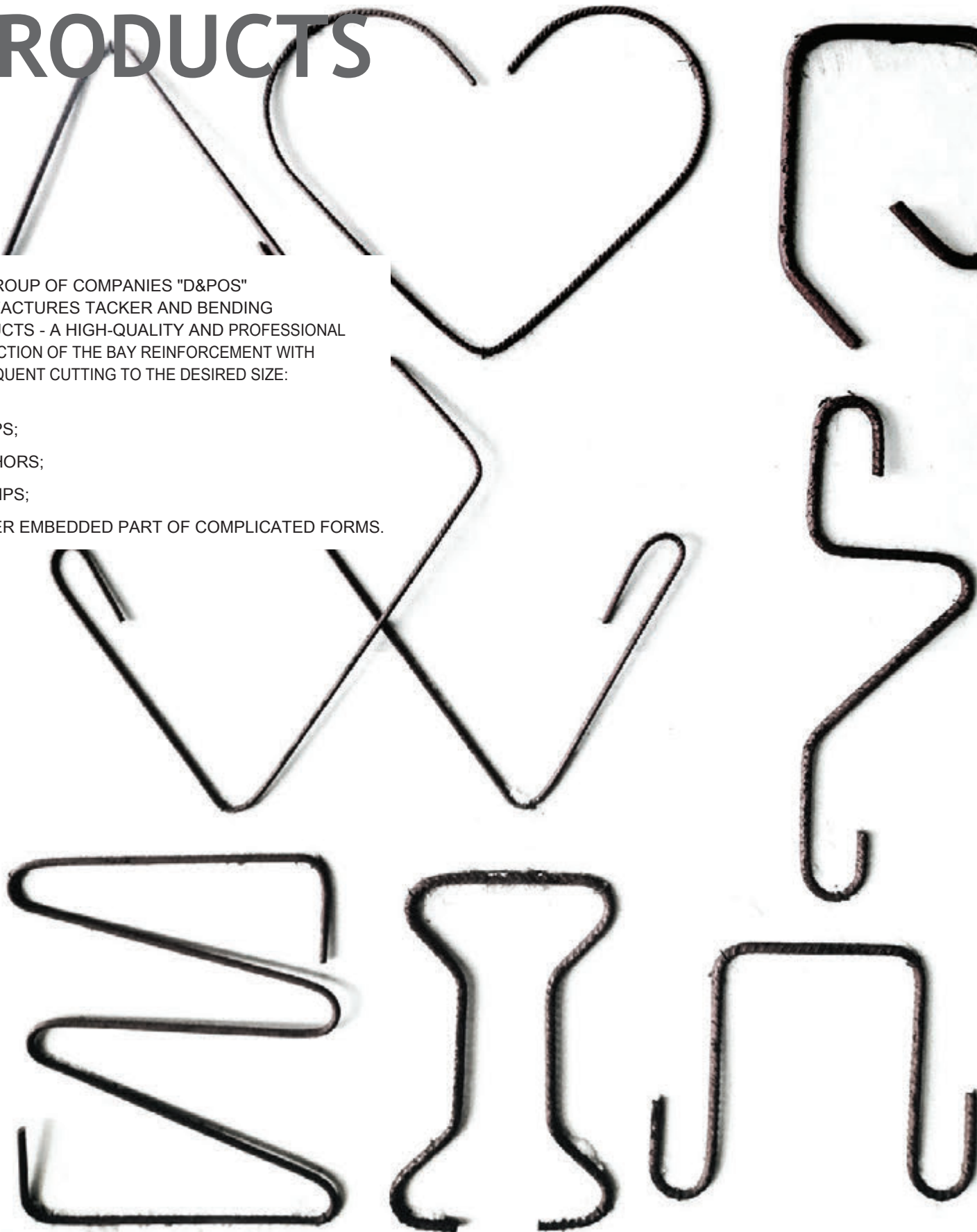

## OUR PRODUCTS

- ◇ do not require storage space for storage;
- ◇ long-distance transport is not needed for transportation;
- ◇ have precise geometrical dimensions, eliminating the need to adjust them to the desired shape and parameters.

## PRODUCTION CAPABILITIES

NAME	SPECIFICATIONS	
Diameter	6 – 12 mm	12 – 40 mm
Material	Hot-rolled fittings, cold-rolled fittings B500C, rolled wire	
Accuracy of the bend angle	1°	
Cutting precision along the length	+/- 1 mm	+/- 10 mm

## OUR ADVANTAGES

- ◇ an assortment consisting of dozens of different shapes and elements;
- ◇ ordering products according to an individual sketch and exactly in time;
- ◇ a high-quality product manufactured on a modern Austrian equipment (process speed up to 200 m/min);
- ◇ significant savings because of the absence of waste;
- ◇ fast and accurate installation of parts in the design position;
- ◇ reduction of time on their manufacturing;
- ◇ compliance of the dimensions with the customer's drawings.

## SCOPE OF APPLICATION

- ◇ ARRANGEMENT OF REINFORCING FRAMES OF REINFORCED CONCRETE PRODUCTS;
- ◇ REINFORCEMENT OF MASONRY IN SEISMIC CONDITIONS;
- ◇ IMPLEMENTATION OF MONOLITHIC, INDIVIDUAL, INDUSTRIAL AND CIVIL CONSTRUCTION.







FAGOR





The background of the slide is a photograph of an industrial facility. It features large blue structural columns and yellow safety railings. In the foreground, there is a yellow metal grid fence. The background shows various pieces of machinery, including what appears to be a large roller or mill, and overhead lighting fixtures. The overall scene is a typical industrial manufacturing environment.

# PROCESSING OF **FLAT-ROLLED** PRODUCTS

- ◇ SLITTING OF COILED STILL
- ◇ CROSSCUTTING OF COILED STEEL
- ◇ PROFILED GRATING
- ◇ EXPANDED STEEL SHEET
- ◇ PIPE PRODUCTS
- ◇ STRUCTURAL SHAPES
- ◇ REINFORCED PROFILES
- ◇ MOUNTING PROFILES
- ◇ FINISHING PROFILES
- ◇ ROLL-FORMED CHANNEL
- ◇ FULL CUT EXTENDED MESH



# SLITTING OF COILED STEEL (TAPE)



"D&POS" CARRIES OUT SLITTING OF COILED HOT-ROLLED, COLD-ROLLED AND GALVANIZED STEEL, STEEL WITH LACQUER COATING, STAINLESS STEEL, ALUMINIUM, COPPER, ELECTRICAL STEEL WITH THE POSSIBILITY OF APPLYING A PROTECTIVE FILM ON FULLY AUTOMATED EQUIPMENT THAT MEETS ALL THE STANDARDS OF MODERN EUROPEAN METAL PROCESSING PRODUCTION.



## WE OFFER

- ◇ cutting of cold-rolled, hot-rolled and galvanized steel, steel with lacquer coating, stainless steel, aluminium, copper, electrical steel;
- ◇ high-quality products - tape, which is manufactured on modern automatic slitting lines produced in Germany, Spain, Italy, South Korea and Russia;
- ◇ quality control of products in our own laboratory, its compliance with all Russian and European standards;
- ◇ steel tapes of various widths, weights, internal and external diameters;
- ◇ possibility of additional application of a protective film (on metal with a thickness of 0.2 mm to 3.0 mm), as well as laying or removing interturn paper (on metal with a thickness of 0.2 mm to 1.5 mm);
- ◇ high cutting speed up to 400 m/min in compliance with the minimum tolerances for the width of the finished tape ( $\pm 0.1$  mm);
- ◇ manufacturing of products in the shortest time possible;
- ◇ maintaining stocks of raw materials and finished products in the warehouse.





# PRODUCTION CAPABILITIES

NAME	SPECIFICATIONS		
Raw material	Cold-rolled, galvanized, pre-lacquered (polymer-coated steel) steels, electrical steel, aluminium, copper, stainless steel	Cold-rolled, galvanized, pre-lacquered (polymer-coated steel) steels, electrical steel	Hot-rolled
Maximum strength limit of the processed material	900 MPa	600 MPa	600 MPa
Thickness of the parent roll	0,2 – 1,5 mm	0,3 – 4,0 mm	1,2 – 7,0 mm
Width of the parent roll	150 – 1 500 mm	400 – 1 800 mm	100 – 1 650 mm
Inner diameter of the parent roll	508 / 610 mm	508 / 610 mm	508 / 610 / 760 / 850 mm
Width of the strip	10 – 1 500 mm	19 – 1 800 mm	19 – 1 650 mm
Inner diameter of the finished products	406 / 508 / 610 mm	508 / 610 mm	508 / 610 / 670 mm
Precision of tape manufacturing	± 0,1 mm	± 0,1 mm	± 0,1 mm for each 2 mm of thickness
Maximum weight of the roll	16 tons	16 tons	16 tons





## SCOPE OF APPLICATION

STEEL TAPE (STRIP) HAS A VERY WIDE RANGE OF APPLICATIONS AND IS USED FOR MANUFACTURING OF:

- ◇ warehouse and shelving equipment;
- ◇ furniture, accessories, safes, metal doors;
- ◇ perforated plates, supports and other elements with complicated geometry;
- ◇ electric-welded pipes;
- ◇ bases for fixing guides that are used in the construction of divide walls, coverings and other structures made of plastic, drywall or other light building materials;
- ◇ packaging of various goods and products (in this case, strong strips perform a double function: they prevent deformation of cardboard or plastic containers, and also serve as a sling that simplifies the movement of cargo);
- ◇ fasteners for the installation of air conditioners, split systems, ventilation equipment;
- ◇ strengthening of fences and barriers, fixing of roof claddings;
- ◇ decorative design (galvanized strips have high aesthetic qualities, which allows them to be used for landscape design or as decorative elements for various designs);
- ◇ electrical, lighting, heat engineering, ventilation equipment;
- ◇ road fences;
- ◇ agricultural and special equipment, elevator equipment;
- ◇ drainback systems.



# CROSSCUTTING OF COILED STEEL (TAPE)



"D&POS" HAS BEEN CARRYING OUT CROSSCUTTING OF METAL **FOR MORE THAN 20 YEARS**. HAVING HUGE EXPERIENCE IN THIS AREA, WE CONSTANTLY WE ARE CONSTANTLY UPDATING OUR EQUIPMENT FLEET IN ORDER TO USE THE MOST MODERN TECHNOLOGIES TO MANUFACTURE A PRODUCT THAT **MEETS RUSSIAN AND FOREIGN QUALITY STANDARDS**.



## WE OFFER

- ◇ cutting of cold-rolled, hot-rolled and galvanized steel, steel with lacquer covering, stainless steel;
- ◇ high-quality tape, which is produced on modern automatic crosscutting lines produced in Spain, Italy, South Korea and Russia;
- ◇ cutting coiled steel into a sheet not only in the form of a square or rectangle, but also in the form of a triangle, trapezoid and parallelogram (cold-rolled, galvanized steel, steel with lacquered covering with a thickness of 0.4 mm to 3.0 mm);
- ◇ blanks in the form of a triangle, trapezoid and parallelogram are widely used in the automotive industry, this allows our customers to reduce waste during further processing.

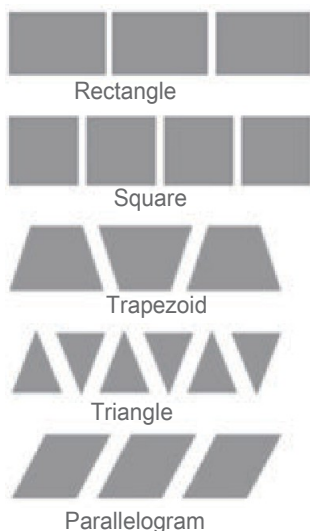

**HIGH QUALITY FLATNESS SHEET,**  
SINCE OUR LINES ARE EQUIPPED WITH MULTI-ROLL  
**CORRECT INSTALLATIONS.**

PRODUCT QUALITY CONTROL IN OUR OWN  
LABORATORY CONFIRMS ITS **COMPLIANCE WITH ALL  
RUSSIAN AND FOREIGN STANDARDS.**

HIGH CUTTING SPEED **UP TO 80 M/MIN,**  
IN COMPLIANCE WITH THE MINIMUM TOLERANCES  
FOR THE LENGTH OF THE SHEET, IT **GUARANTEES**  
THE PRODUCTION OF **HIGH-QUALITY PRODUCTS IN  
THE SHORTEST TIME POSSIBLE.**



# PRODUCTION CAPABILITIES

NAME	SPECIFICATIONS		
Raw material	Cold-rolled, galvanized, pre-lacquered (polymer-coated steel) steels	Cold-rolled, galvanized, pre-lacquered (polymer-coated steel) steels	Cold-rolled, galvanized, hot-rolled steels
Maximum strength limit of the processed material, MPa	600	600	600
Thickness of the parent roll, mm	0,4÷3,0	0,2÷1,2	1,0÷6,0
Width of the parent roll, mm	310÷1850	240÷1400	20÷1500
Inner diameter of the parent roll, mm	508/610	508/610	508/610/700/750/800/850
Length of the finished products, mm	270÷7000	220÷3000	145÷12000
Forms of the finished products	Square, rectangle, triangle, trapezoid, parallelogram.	Square, rectangle	Square, rectangle
Manufacturing accuracy in length, mm	± 0,5	± 0,5 per run meter of length	± 1,0 per run meter of length
Maximum weight of the finished pack, tons	6	5	4
Angle of rotation of knives	60°	0° (first cut)	0° (first cut)





## SCOPE OF APPLICATION

- ◇ AUTOMOBILE CONSTRUCTION;
- ◇ MANUFACTURING OF FURNITURE, SAFES AND CABINETS;
- ◇ FORGING, PRESSING, STAMPING AND PROFILING;
- ◇ MACHINE BUILDING;
- ◇ MANUFACTURING OF HOUSEHOLD AND MEDICAL EQUIPMENT;
- ◇ MANUFACTURING OF VENTILATION EQUIPMENT;
- ◇ MANUFACTURING OF ELEVATOR EQUIPMENT;
- ◇ MANUFACTURING OF METAL DOORS;
- ◇ MANUFACTURING OF LIFTING EQUIPMENT;
- ◇ MANUFACTURING OF CONTAINERS, RADIATORS, CATTLES AND TARES;
- ◇ MANUFACTURING OF AGRICULTURAL EQUIPMENT AND SPECIAL TECHNIC;
- ◇ MANUFACTURING OF LIGHTING EQUIPMENT;
- ◇ MANUFACTURING OF COMMERCIAL AND REFRIGERATION EQUIPMENT;
- ◇ MANUFACTURING OF ELECTRIC EQUIPMENT;
- ◇ MACHINE TOOL ENGINEERING;
- ◇ SHELVING MANUFACTURING;
- ◇ SHIPBUILDING.



# PROFILED GRATING



**PROFILED GRATING** IS FACING AND ROOFING MATERIAL THAT IS METAL CORRUGATED SHEETS, WHICH ARE MANUFACTURED BY COLD ROLLING.

THE OWN EQUIPMENT OF "D&POS" ALLOWS TO MANUFACTURE **ALL TYPES OF PROFILED GRATING WITH GALVANIZED OR LACQUERED COATING** ON AN INDIVIDUAL ORDER.



**TYPES OF PROFILED GRATING BY TYPES OF COATINGS:**

- ◇ galvanized;
- ◇ with a one-sided polymer coating.

**TYPES OF PROFILED COATING BY AREAS OF APPLICATION:**

- ◇ **Roofing profiled grating** - perfect for roofing. Corrugated profile contributes to the directional flow of water, the material is not subject to corrosion. These qualities allow to preserve it in a perfect condition for many years.
- ◇ **Wall profiled grating** is used for wall cladding. The profiled grating is perfectly combined with any architectural style of the building, modern technologies make it possible to produce profiled sheets in any color scheme that is suitable specifically for the facade of your house.

## SCOPE OF APPLICATION

- ◇ WALL COVERING OF WORKSHOPS, WAREHOUSES, TRADE PAVILIONS, HANGARS, COTTAGES, GARDEN AND COUNTRY HOUSES;
- ◇ ROOF CLADDING;
- ◇ GATES AND FENCES;
- ◇ FLOOR DECKS.



## ADVANTAGES OF THE PROFILED GRATING

- ◇ rigidity;
- ◇ longevity;
- ◇ easy installation;
- ◇ durability;
- ◇ easy transportation;
- ◇ wide range of colors;
- ◇ visual appeal;
- ◇ protection from corrosion;
- ◇ light weight.



## WE OFFER

- ◇ products manufactured in accordance with GOST 24045 and TR;
- ◇ compliance of the thickness with the declared parameters: the company's own laboratory carries out incoming quality control of raw materials;
- ◇ manufacturing of sheets on an individual order with a length of 0.5 m to 16 m;
- ◇ a large range of color options for profiled grating with lacquer coating.



### **THE PRODUCTS MAY BE COVERED WITH A PROTECTIVE FILM ON AN INDIVIDUAL ORDER**

Contact paper is applied for the protection of smooth metal surfaces: painted, varnished, synthetic materials (PVC, melamine) from various kinds of contamination and damage during processing, storage, transportation and further work.

The films for temporary protection of surfaces are ecologically safe and can be removed without any sign after utilisation. The protective film must be immediately removed after installation.

In addition to the profiled grating, it is possible to supply additional elements for the roof of our own production: a comb or an end cap. Also, roofing (4,8x35 mm) and fence (5,5x19 mm) screws are constantly available in stock.

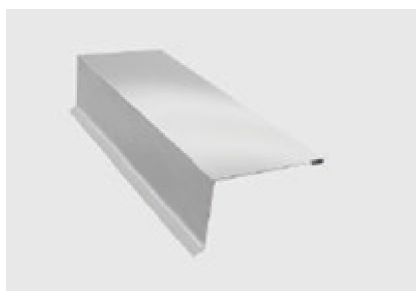

An **end cap** protects the profiled sections along the pediment (the section of the wall that is bounded from below by the ceiling, and from above by the planes of the roof slopes) from the wind load of the fastener failure.

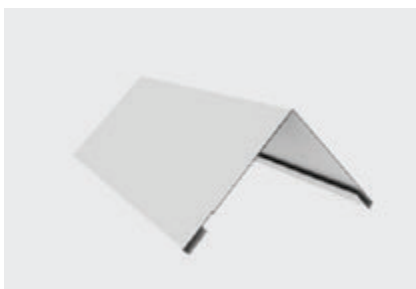

A **comb** is the simplest device with a single longitudinal bend. It closes the profiled sheets on the comb, external fractures of the roof, protecting them from moisture, dirt in the under-roof space and the breakdown of profiled sheets by gusts of wind.



# PRODUCTION CAPABILITIES

PROFILED SHEET C8-1170

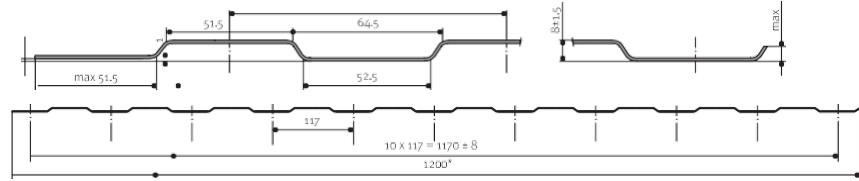

PROFILED SHEET C10-1100

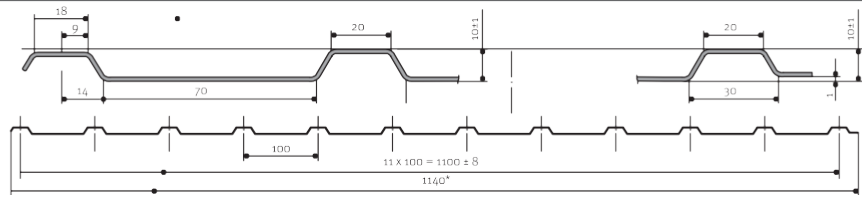

PROFILED SHEET C21-1000

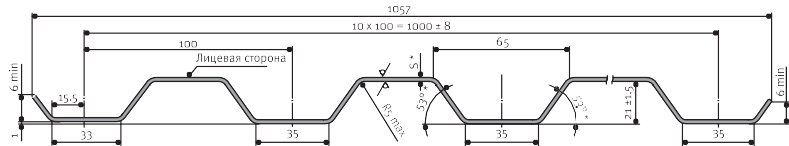

PROFILED SHEET HC35-1000

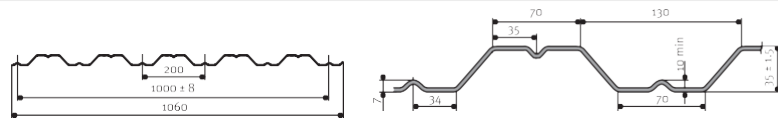

PROFILED SHEET HC44-1000

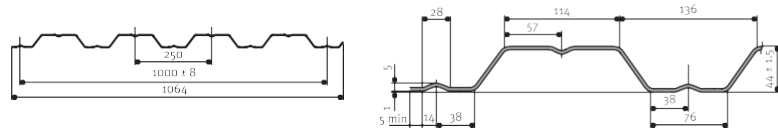

PROFILED SHEET H57-864

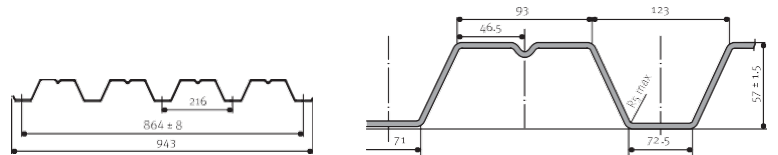

PROFILED SHEET H75-750

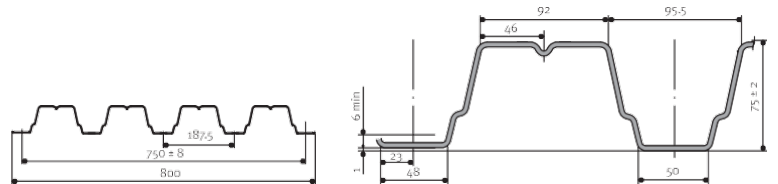

PROFILED SHEET H114-600

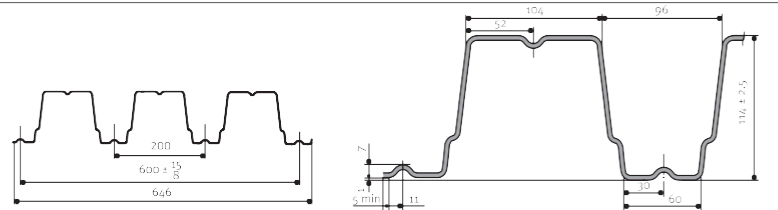

PROFILED SHEET H114-750

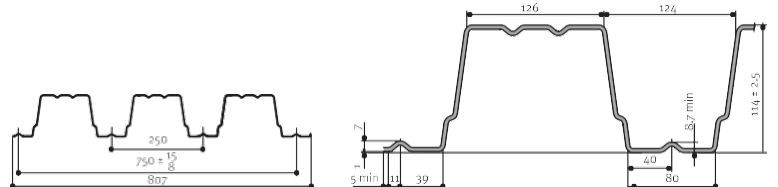

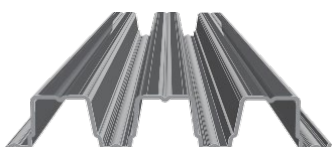
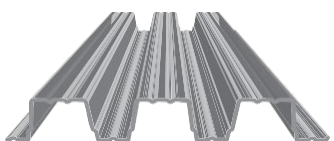
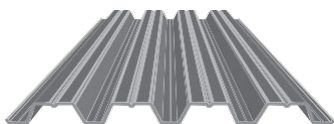
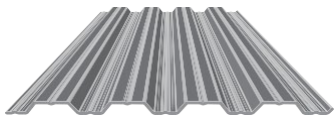
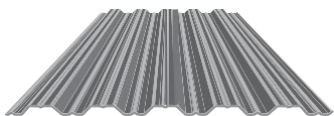
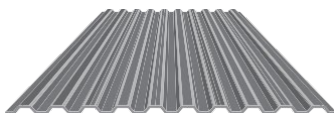
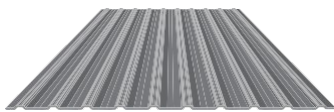
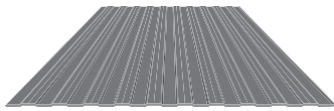

BRAND	THICKNESS, MM	MASS, RM, KG	MASS 1 M <sup>2</sup> , KG
C8-1170-0,5	0.5	5.4	4.7
C8-1170-0,55	0.55	5.9	5.13
C8-1170-0,6	0.6	6.4	5.57
C8-1170-0,7	0.7	7.4	6.43
C10-1100-0,5	0.5	5.4	4.9
C10-1100-0,55	0.55	5.9	5.4
C10-1100-0,6	0.6	6.4	5.8
C10-1100-0,7	0.7	7.4	6.7
C21-1000-0,55	0.55	5.9	5.9
C21-1000-0,6	0.6	6.4	6.4
C21-1000-0,7	0.7	7.4	7.4
HC35-1000-0,6	0.6	6.4	6.4
HC35-1000-0,7	0.7	7.4	7.4
HC35-1000-0,8	0.8	8.4	8.4
HC44-1000-0,7	0.7	7.3	7.3
HC44-1000-0,8	0.8	8.4	8.4
HC44-1000-0,9	0.9	9.3	9.3
H57-864-0,6	0.6	6.41	7.5
H57-864-0,7	0.7	7.4	8.7
H57-864-0,8	0.8	8.4	9.8
H75-750-0,7	0.7	7.4	9.8
H75-750-0,8	0.8	8.4	11.2
H75-750-0,9	0.9	9.3	12.5
H114-600-0,8	0.8	8.4	14.0
H114-600-0,9	0.9	9.3	15.5
H114-600-1,0	1.0	10.3	17.7
H114-750-0,7	0.7	8.3	11
H114-750-0,8	0.8	9.4	12.5
H114-750-0,9	0.9	10.5	14.0
H114-750-1,0	1.0	11.7	15.4
H114-750-1,2	1.2	13.8	18.4



# EXPANDED STEEL SHEET



**EXPANDED STEEL SHEET** IS A SPECIAL METAL MESH OF MONOLITHIC CONSTRUCTION. IT IS MANUFACTURED OF SHEET STEEL BY THE METHOD OF CUTTING AND DRAWING, AS A RESULT OF WHICH CELLS APPEAR IN PLACE OF THE CUTS. THE OBTAINED MESH HAS 80% LESS SPECIFIC WEIGHT THAN A WHOLE SHEET WITH PRACTICALLY THE SAME MECHANICAL STRENGTH.

## ADVANTAGES OF THE EXPANDED STEEL SHEET

- ◇ durability, rigidity, resistance to deformation;
- ◇ lightness of construction;
- ◇ self-cleaning (dirt can freely fall through the holes);
- ◇ protection from sliding;
- ◇ ensuring light and air permeability;
- ◇ large overlapping area of the object;
- ◇ 80% lighter compared to a solid sheet of similar overall dimensions.

# SCOPE OF APPLICATION

- ◇ manufacturing of stairs and flights of stairs;
- ◇ installation of fences along highways that are capable of scattering the headlights of oncoming vehicles;
- ◇ manufacturing of fences for summer cottages and household plots;
- ◇ reinforcement of concrete structures;
- ◇ ensuring reliable adhesion of plaster compounds to the wall surface;
- ◇ manufacturing of containers and equipment for mining enterprises;
- ◇ manufacturing of plugs for ventilation shafts, air ducts, roof windows;
- ◇ decoration of various architectural elements;
- ◇ screening of soil and other bulk materials;
- ◇ creation of bridges and galleries;
- ◇ manufacturing of special equipment;
- ◇ construction of sites for storage and maintenance of drilling equipment.



# PRODUCTION CAPABILITIES

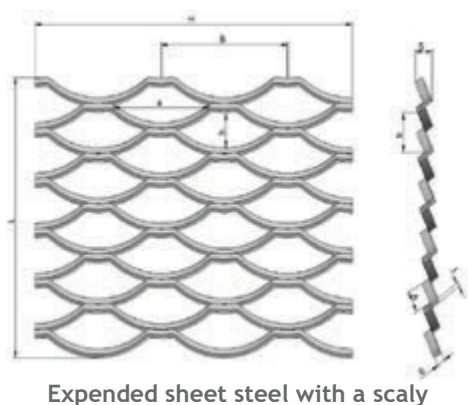
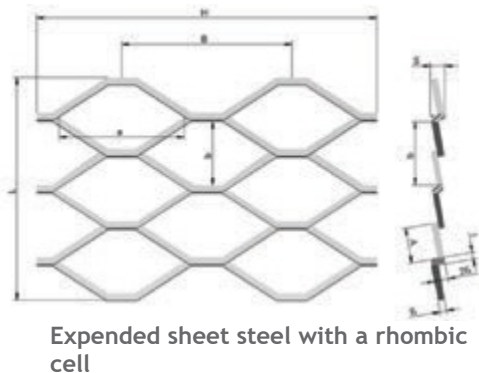

NAME	SPECIFICATIONS
Thickness	3,0 – 6,0 mm
Width	500 – 1 300 mm (+/- 10 mm)
Length	500 – 3500 mm (+/- 25 mm)

# WE OFFER

- ◇ products in stock and on order;
- ◇ execution of orders on time;
- ◇ possibility of ordering according to individual parameters;
- ◇ manufacturing from sheet carbon steel with a thickness of 3.0 mm to 6 mm grades St3kp, St3sp and St3ps in accordance with GOST 380, it is allowed to manufacture expanded sheet steel from other materials;
- ◇ manufacturing of products on modern German equipment;
- ◇ use of waste-free production technology;
- ◇ form of cells - rhombic and scaly;
- ◇ manufacturing of products in compliance with TR 5262-001- 57099372, TR 5262-007-57099372.

### The characteristics of expanded steel sheet are:

L - length of expanded steel sheet, H - width of expanded steel sheet, t - thickness of the workpiece material, a - width of the cell, b - height of the cell, V - cutting pitch (supply), S - height of expanded steel sheet, B - pitch of cell, A - amount of extraction.

### Deviation from the dimensions is allowed:

2A – ±4,5 mm, B – ±15%, V – ±2%



# PIPE PRODUCTS

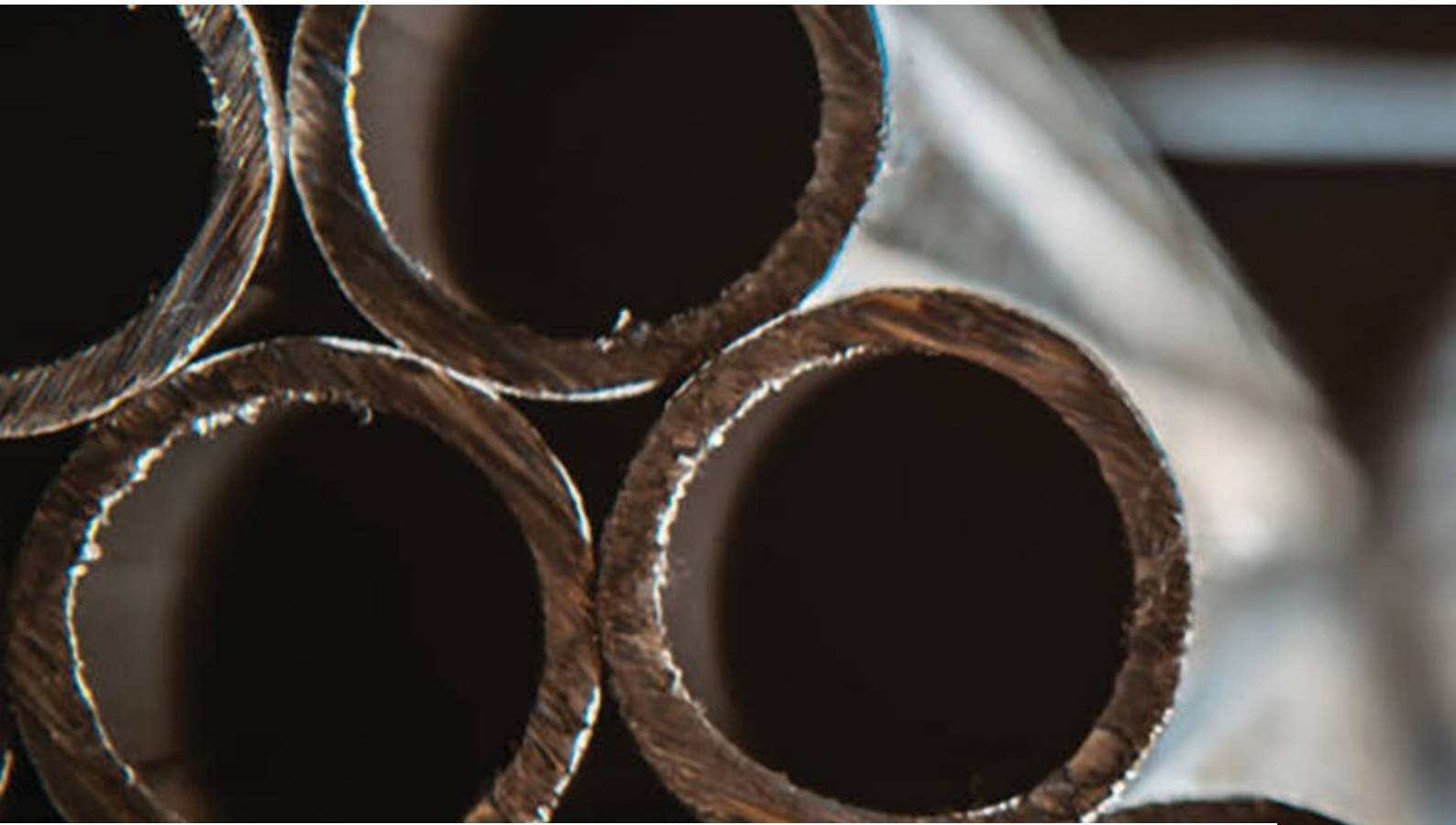

**PIPE PRODUCTS** ARE WIDELY USED IN CONSTRUCTION, AGRICULTURAL, ENERGY, OIL AND GAS, CHEMICAL, TRANSPORT, HOUSING AND COMMUNAL SERVICES AND OTHER INDUSTRIES.

"D&POS" HAS A HUGE EXPERIENCE IN MANUFACTURING AND SUPPLY OF PIPE PRODUCTS AND IS READY TO OFFER SOLUTIONS OF ANY TASKS OF OUR PARTNERS.

WE OFFER A WIDE RANGE OF RELATED PRODUCTS: CONNECTING PIECES AND PIPELINE FITTINGS.

## ADVANTAGES OF WORKING WITH "D&POS"

- ◇ we offer a wide range of pipes from stock (more than 500 items);
- ◇ we provide a complete set of pipe products with connecting pieces and pipeline fittings;
- ◇ we provide a complete set of long and flat rolled products, as well as products of our own production (mesh, gratings, etc);
- ◇ we are ready to manufacture and supply pipe products with additional requirements in a short time (non-standard steel grades, wall thicknesses and lengths, bevelling, bending, application of protective coatings, galvanizing, painting, various types of tests in our own laboratory).



AT THE WAREHOUSE COMPLEXES "D&POS", YOU CAN ALWAYS FIND **A WIDE RANGE OF ELECTRIC-WELDED AND SEAMLESS PIPES** MANUFACTURED BY JSC "VMZ", PJSC "SEVER-STEEL", AE "TEMPO", JSC "URALTRUBPROM", PJSC "TMK", PJSC "CHTPZ", AS WELL AS PIPES OF OWN PRODUCTION OF "VERKHNEVOLZHISKY SMC".



# SHAPED PIPES

## SHAPED PIPES

- ◇ profile pipes of square section;
- ◇ profile pipes of rectangular section;
- ◇ plane-oval pipes.

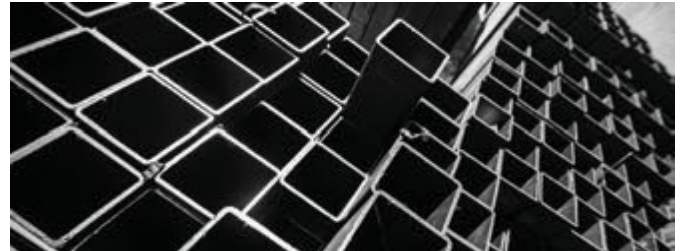

## SCOPE OF APPLICATION OF SHAPED PIPES

- ◇ construction industry;
- ◇ manufacturing of steel structures;
- ◇ manufacturing of metalware;
- ◇ manufacturing of fences and enclosures;
- ◇ manufacturing of furniture.



## PRODUCT RANGE

NAME	SPECIFICATIONS
Perimeter of pipes	Square profile pipes 10x10 mm - 400x400 mm Rectangular profile pipes 20x10 mm - 500x400 mm
Wall thickness	1,2 mm – 12 mm
Length	6000, 8500, 9000, 11000, 12000 mm
Steel grades	1-3sp/ps, 3sp/ps5, 3ps/sp5, 08ps, 09G2S, 09G2S-12, 09G2S-14, 09G2S-15, st.20, S245, S255, S345
Reference documentation	GOST 3262, GOST 8645, GOST 8639, GOST 13663, GOST 30245, DIN EN 10219-1, 2

## ADDITIONAL SERVICES

- ◇ manufacturing of pipes of non-standard length and thickness;
- ◇ cutting to the required size;
- ◇ bottoming and painting;
- ◇ drilling;
- ◇ bending.

# SMALL AND MEDIUM ROUND PIPES

## TYPES OF ROUND PIPES

- ◇ electric-welded pipes (longitudinally welded and spiral welded);
- ◇ seamless pipes.



## SCOPE OF APPLICATION OF ROUND PIPES

- ◇ construction industry (pipelines, piles, pipe shunt, metal structures);
- ◇ agriculture (irrigation systems);
- ◇ energy industry (construction of theological pipelines);
- ◇ housing and communal services (water pipes, steam lines, cases);
- ◇ oil and gas and petrochemical industries (pipelines for various purposes, piles);
- ◇ furniture industry.

## PRODUCT RANGE

NAME	SPECIFICATIONS
Diameter	15, 20, 25, 32, 40, 50, 57, 65, 76, 80, 89, 102, 108, 114, 133, 146, 159, 168, 219, 325, 377, 426, 530 mm
Wall thickness	1 – 25 mm
Length	6 000 – 12 000 mm
Steel grades	st. 3, st. 10, st. 20, 09G2S, gr. D, 13XFA, 20XX, etc.
Reference documentation	GOST 10705 (general purpose pipes), TR 14-105-737, GOST 3262 (water and gas pipes), GOST 8732, GOST 20295, etc.
Coatings	Zinc coating, external and internal anti-corrosion coating, polyurethane foam insulation, primer coating, anti-corrosion paints
Tests	<ul style="list-style-type: none"> <li>◇ multiple stage non-destructive control;</li> <li>◇ acceptance mechanical tests of the base metal and the welding connection of pipes;</li> <li>◇ 100% hydraulic pressure control.</li> </ul>

## ADDITIONAL SERVICES

- ◇ cutting-to-length;
- ◇ galvanizing;
- ◇ painting;
- ◇ coating (external, internal, PU foam).



# LARGE DIAMETER PIPES

## TYPES OF PIPES

- ◇ pipes with one longitudinal seam;
- ◇ pipes with two longitudinal seams.

## SCOPE OF APPLICATION OF LARGE DIAMETER PIPES

- ◇ construction industry;
- ◇ construction of water pipelines, heating systems;
- ◇ energy industry (construction of pipelines);
- ◇ housing and communal services (construction of pipelines);
- ◇ oil and gas industry (construction of pipelines).



## PRODUCT RANGE

NAME	SPECIFICATIONS
Diameter	530, 630, 720, 820, 920, 1020, 1220, 1420 mm
Wall thickness	8 – 50 mm
Length	up to 12 000 mm
Steel grades	K50, K52, K54, K55, K56, K60, K65, and steel S275, S355, S420, S460, C275, C345, C375, C390, C440, C590 St3Sp, 20, 09G2S, 17G1S, 17G1S-U
Reference documentation	GOST 10706, GOST 20295, TR 1381-103-05757848
Coatings	External anti-corrosion three-layer polyethylene or polypropylene coating or one- and two-layer epoxy coating. Internal smooth or anti-corrosion coating. PU foam thermal insulation in a protective shell.
Tests	<ul style="list-style-type: none"> <li>◇ input quality control of sheet steel and welding materials;</li> <li>◇ non-destructive control;</li> <li>◇ hydraulic tests of each pipe;</li> <li>◇ mechanical tests of the base metal and the welded seam of pipes.</li> </ul>

# TUBULARS MANUFACTURED AT "VERKNEVOLZHSKY SMC"



AT "VERKNEVOLZHSKY SMC" IN IVANOVO (A PART OF THE GROUP OF COMPANIES "D&POS"), THERE IS AN AUTOMATED PRODUCTION LINE FOR WELDED CIRCULAR AND PROFILE PIPES.

LINE CAPACITY: **25,000 TONS PER YEAR**

## PRODUCTION CAPABILITIES

NAME	SPECIFICATIONS
Perimeter of pipes	Square profile pipes 10x10 mm - 400x400 mm Rectangular profile pipes 20x10 mm - 500x400 mm
Wall thickness	1,2 mm – 12 mm
Length	6000, 8500, 9000, 11000, 12000 mm
Steel grades	1-3sp/ps, 3sp/ps5, 3ps/sp5, 08ps, 09G2S, 09G2S-12, 09G2S-14, 09G2S-15, st.20, S245, S255, S345
Reference documentation	GOST 3262, GOST 8645, GOST 8639, GOST 13663, GOST 30245, DIN EN 10219-1, 2

## ADDITIONAL SERVICES

- ◇ cutting-to-length;
- ◇ manufacturing of pipes of non-standard length and thickness;
- ◇ packaging in paper and pallets;
- ◇ removal of inside bead;
- ◇ bottoming and painting;
- ◇ hot galvanizing.



# STRUCTURAL SHAPES



**STRUCTURAL SHAPES** (KNAUF TYPE) ARE MANUFACTURED OF A HIGH-QUALITY GALVANIZED STEEL ON A MODERN ITALIAN EQUIPMENT. THEY ARE USED FOR CREATION OF CARRYING FRAMES WITH SUBSEQUENT FINISHING WITH DRYWALL, CLAPBOARD, SIDING AND OTHER FINISHING MATERIALS.

# TYPES OF STRUCTURAL SHAPES

**Studs** - the studs have the shape of a square letter "C" and are used as vertical racks for partitions and linings;

**Channels** - the channels are used for the installation of guides for studs, as well as for the installation of lintels between them;

**Ceiling channels** - the ceiling channels are used during installation of the frame of floating ceiling.

## ADVANTAGES OF OUR PRODUCTS

- ◇ a large number of standard sizes of shapes;
- ◇ a wide range of thicknesses;
- ◇ accurate geometry;
- ◇ strengthening knurling;
- ◇ presence of strengthening ribs;
- ◇ labeling;
- ◇ manufacture according to TR 1108-006-57099372;
- ◇ manufacturing of high-quality galvanized steel on an automated line Italian line;
- ◇ possibility to manufacture shapes of non-standard sizes;
- ◇ increased structural capabilities;
- ◇ the channels have holes for installing dowels, and the studs have H-shaped holes for laying communications.

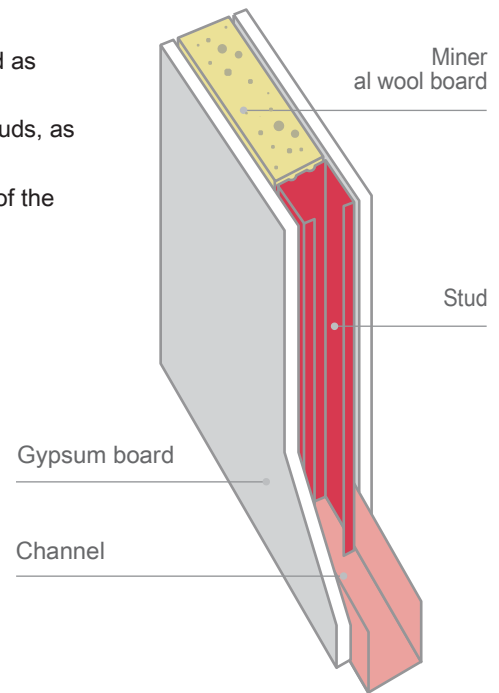



# PRODUCTION CAPABILITIES

NAME	SPECIFICATIONS
Material of shapes	Galvanized steel according to GOST R 14918
Metal thickness	From 0.4 to 0.7 mm
Length of the shape	Standard 3 m; 4 m (it is possible to manufacture non-standard sizes from 1 to 9 m)





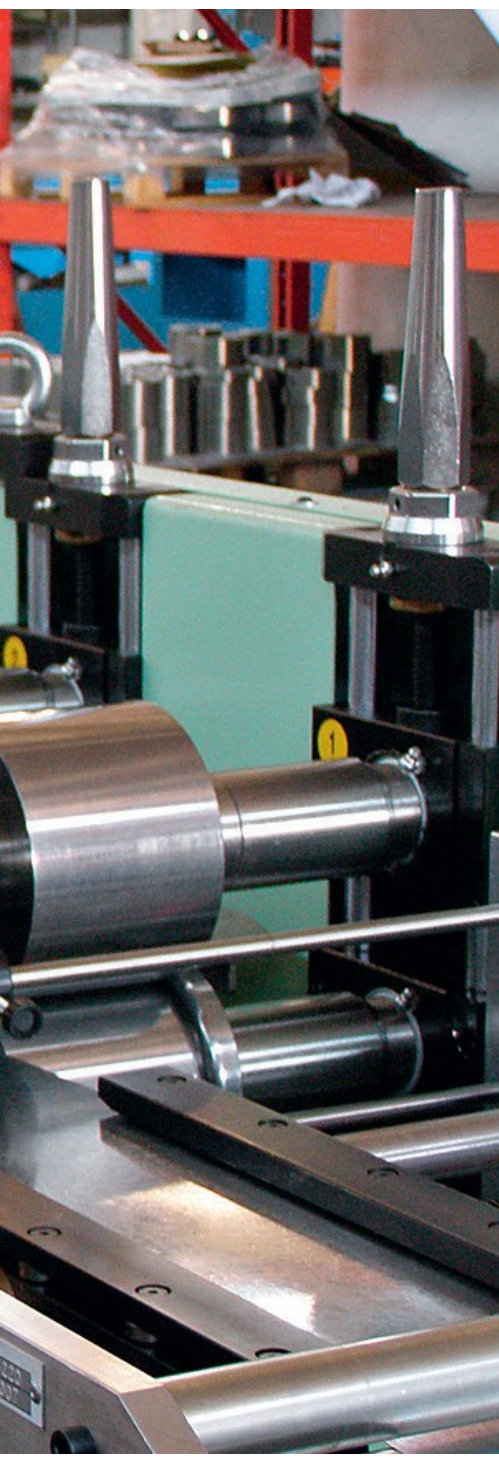
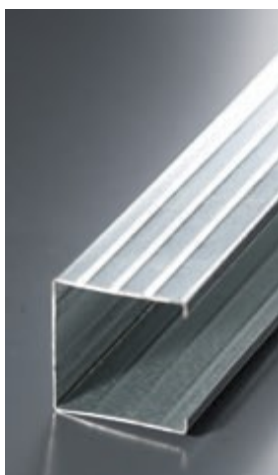

NAME	SKETCH	THICKNESS,
<b>CEILING CHANNEL</b>		
C CH 60 x 27		0,5; 0,6
<b>CHANNELS</b>		
CH 28 x		0,5;
C CH 50 x 40		0,5; 0,6
C CH 75 x		0,5;
C CH 100 x		0,5;
<b>STUDS</b>		
ST 50 x		0,5;
ST 75 x		0,5;
ST 100 x		0,5;



# REINFORCED PROFILES



"D&POS" OFFERS A WIDE RANGE OF REINFORCE PROFILES OF ITS OWN PRODUCTION.

**REINFORCED PROFILE** IS A STEEL REINFORCING ELEMENT LOCATED INSIDE THE PVC WINDOW PROFILE AND NECESSARY FOR STIFFENING OF THE WINDOW CONSTRUCTION.

METAL REINFORCED PROFILED ARE ELEMENTS WITH A LENGTH OF 6 M WITH THE MANDATORY PRESENCE OF A GALVANIZED COATING. GALVANIZED COATING IS RELIABLY CONNECTED WITH THE SURFACE OF THE METAL AND FORMS AN EFFECTIVE PROTECTION OF THE REINFORCING PROFILE INSIDE THE WINDOW.

# ADVANTAGES OF WORKING WITH "D&POS"

- ◇ manufacturing on a modern Italian equipment;
- ◇ wide range of reinforced profiles of our own production for the following systems: VEKA, KBE, REHAU, GEALAN, MONTBLANC, PLAFEN, ROLPLASTO, ELEX, KALEVA, GUTWERK, DECEUNINCK;
- ◇ manufacturing of profiles according to TR 1108-005-57099372;
- ◇ correct geometry and actual thickness of the profile;
- ◇ ability to manufacture products of non-standard sizes on an individual order;
- ◇ mandatory quality control carried out in our own certified laboratory.

## PRODUCTION CAPABILITIES

NAME	SPECIFICATIONS
Material	Galvanized steel according to GOST 14918
Metal thickness	1,0 – 2,0 mm
Length of the shape	Standard up to 6 m (it is possible to manufacture non-standard sizes)



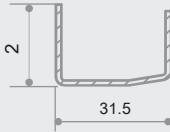

# TYPES OF MANUFACTURED PROFILES

NAME	SKETCH	THICKNESS, MM	ANALOG
RP 31.5 x		1,5;	KBE

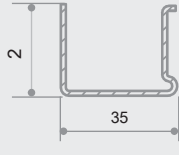
NAME	SKETCH	THICKNESS, MM	ANALOG
RP 35 x		1,5;	REHAU 244506

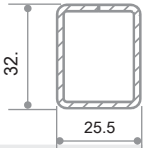
RP 25.5 x		1,5;	KBE
-----------	---	------	-----

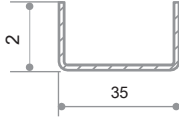
RP 35 x 20		1,5; 1,2	REHAU 245536
------------	--	----------	--------------

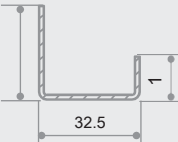
RP 32.5 x 30.5 x		1,5;	KBE
------------------	--	------	-----

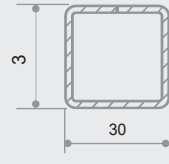
RP 30 x		1,5;	VEKA 113.02
---------	---	------	-------------

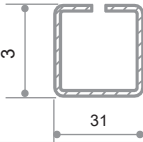
RP 31 x		2.0	KBE
---------	---	-----	-----

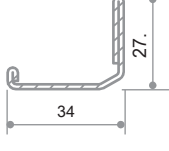
RP 34 x 27.8		1,5;	VEKA 113.229
--------------	--	------	--------------

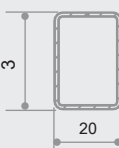
RP 20 x		1,5;	KBE
---------	---	------	-----

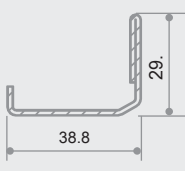
RP 38.8 x		1,5;	VEKA 113.29
-----------	--	------	-------------

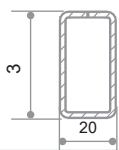
RP 20 x		1,5;	KBE
---------	---	------	-----

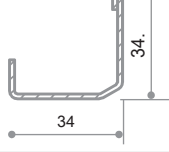
RP 34 x		1,5;	VEKA 113.30
---------	--	------	-------------

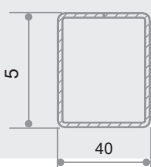
RP 40 x		2.0	KBE 614 REHAU 251886
---------	---	-----	-------------------------

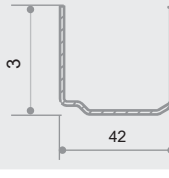
RP 42 x		2.0	VEKA 113.14
---------	--	-----	-------------







# MOUNTING PROFILES

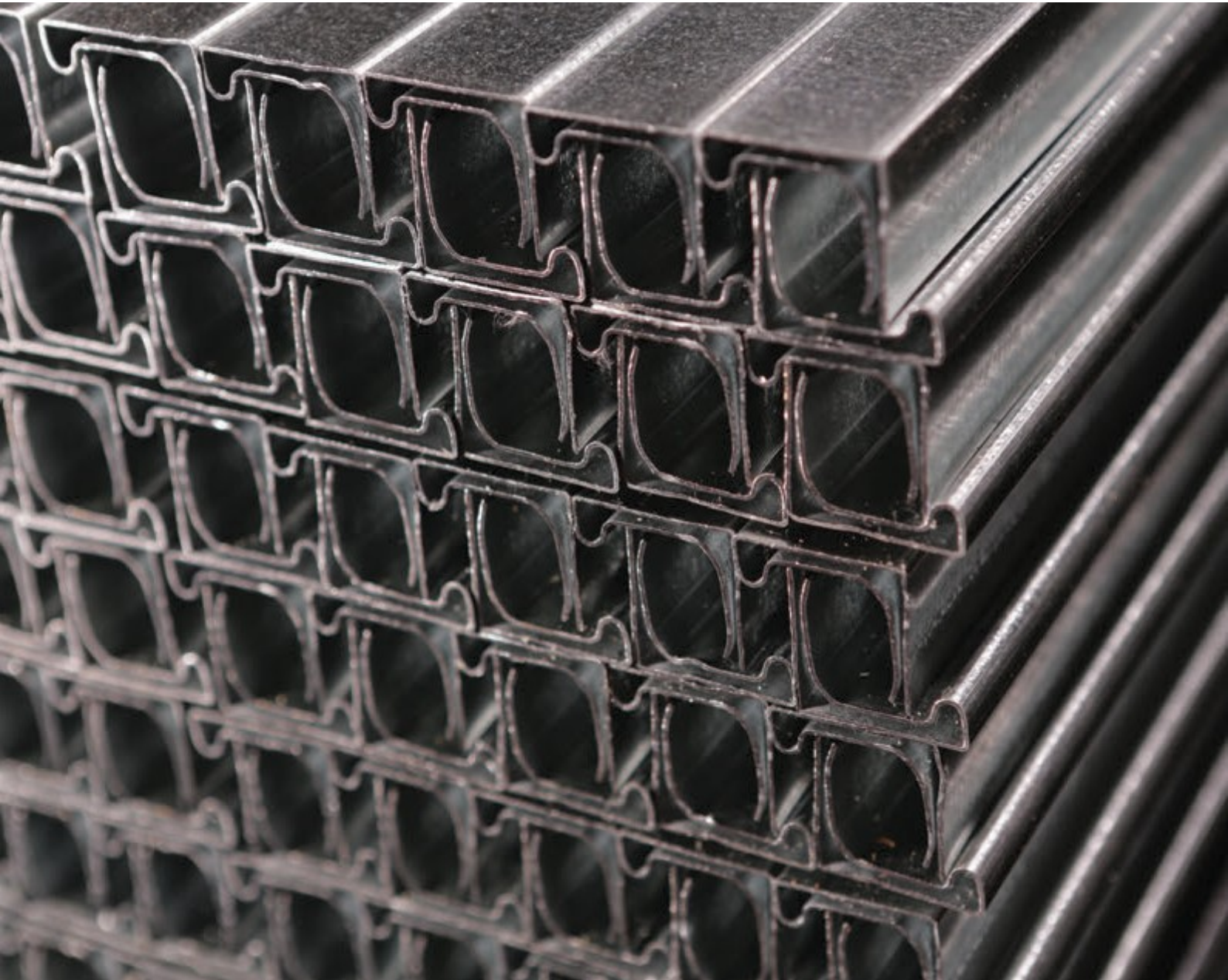

## **MOUNTING PROFILE (MOUNTING RALE)**

IT IS A METAL PROFILE, WHICH IS USED IN MANUFACTURING OF RECTANGULAR AIR DUCTS FOR THE ASSEMBLY OF FLANGES.

# TYPES OF MOUNTING PROFILES

**Rail No. 20** - for air ducts with a side up to 1200 mm;

**Rail No. 30** - for air ducts with a side up to 1200 mm.

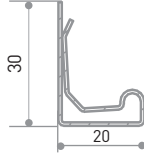
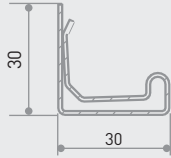
NAME	SKETCH	THICKNESS, MM
Mounting rail No. 20 MP 20		0,5—0,7
Mounting rail No. 30 MP30		0,7—0,9

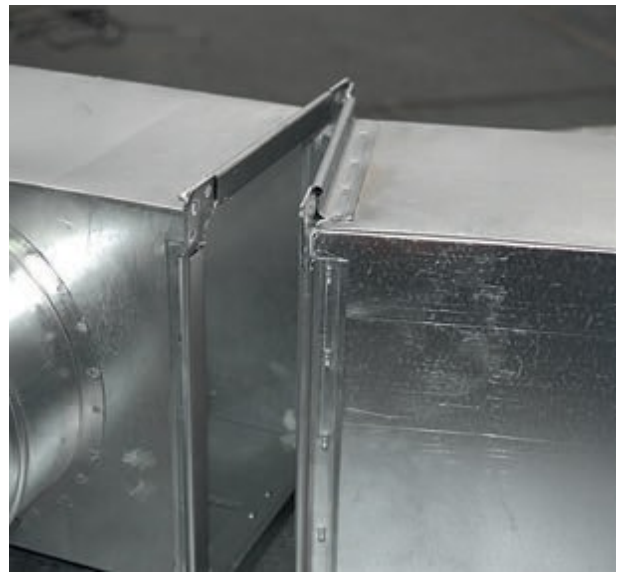

## PRODUCTION CAPABILITIES

NAME	SPECIFICATIONS
Material	Galvanized steel according to GOST R 52246
Metal thickness	0,5 – 0,9 mm
Length of the shape	3 m (it is possible to manufacture non-standard profiles)

## ADVANTAGES OF WORKING WITH "D&POS"

- ◇ manufacturing on a modern Italian equipment 1108-006-57099372;
- ◇ it is possible to order profiles of a non-standard length;
- ◇ tightness of the structure due to tight fit and high reliability of the fastener.



# FINISHING PROFILES

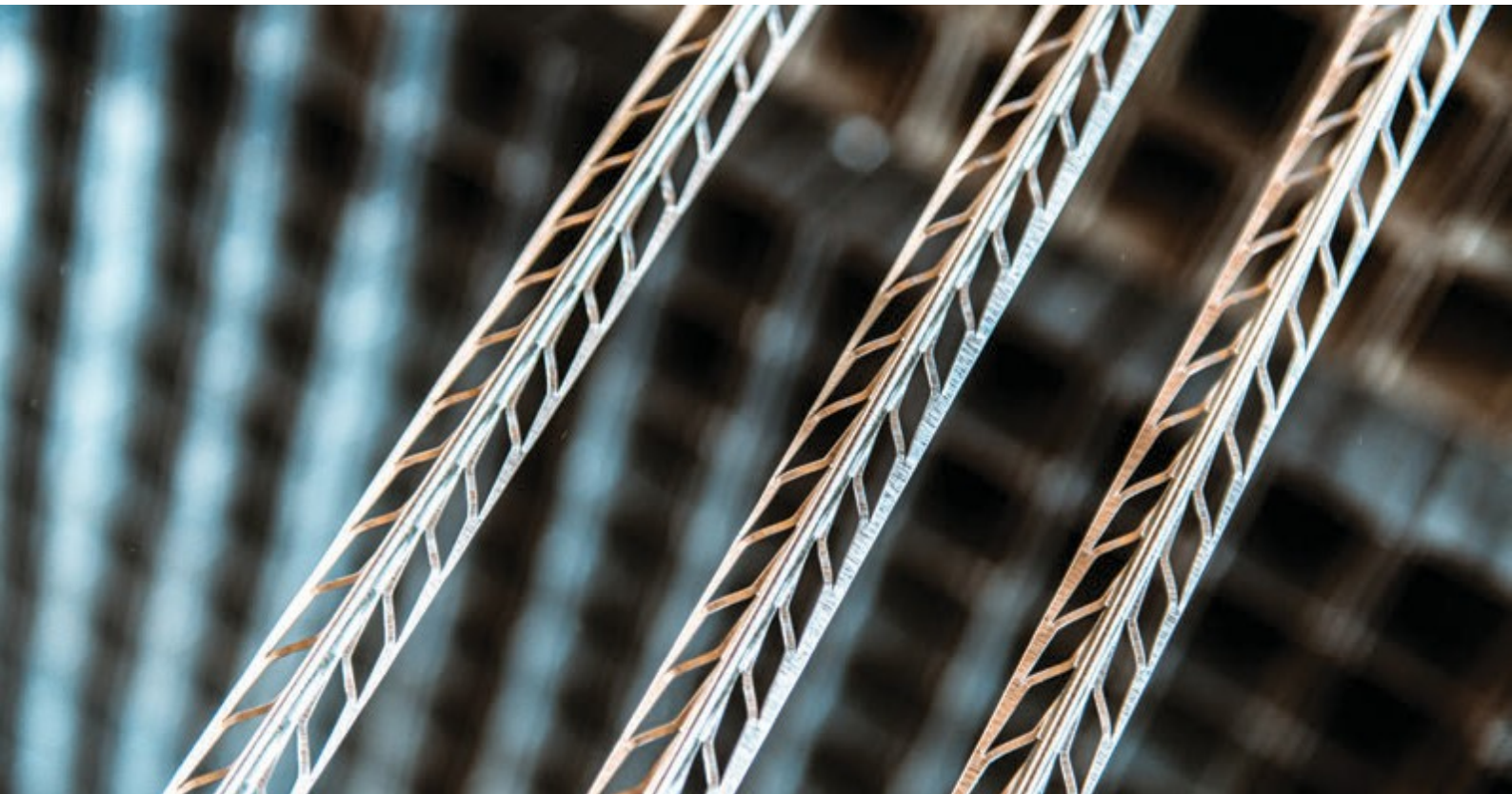

## TYPES OF FINISHING PROFILES

NAME	SKETCH	SIZES
Angle section		20 x 20 mm 25 x 25 mm
Lighthouse section		6 mm, 10 mm

# ADVANTAGES OF OUR PRODUCTS

- ◇ prevention of deformation (all production is packed in cardboard boxes);
- ◇ due to the original branched surface of the side walls of corners and beacons, plaster and putty mixtures hold better and do not crack after drying;
- ◇ presence of certificate of conformity RUSS AU AYU31.H12311;
- ◇ manufacturing according to TR 1108-009-57099372;
- ◇ manufacturing on modern automated lines using patented technology;
- ◇ lower weight with the same stiffness;
- ◇ increasing the productivity of finishings;
- ◇ fast installation.

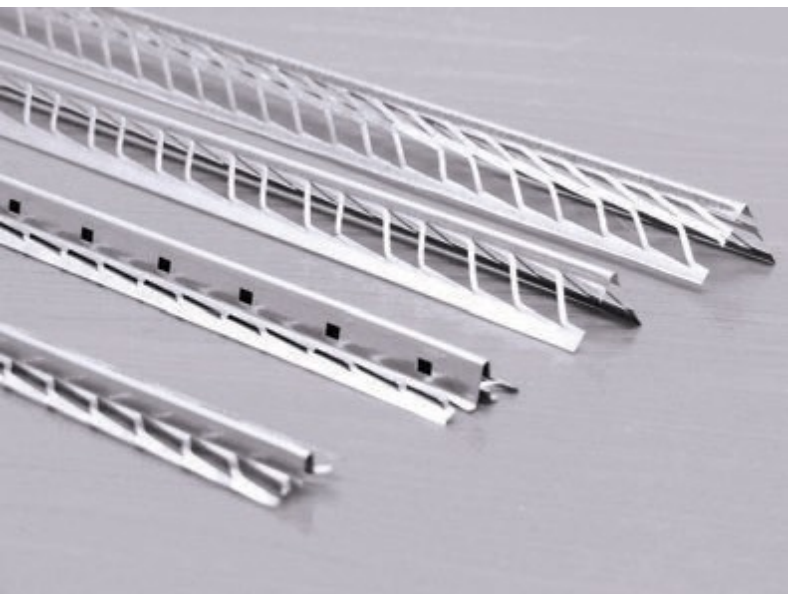

## ANGLE SECTION

ANGLE IS A NECESSARY ELEMENT FOR EDGING THE CORNERS OF THE WALLS.

- ◇ the angle section protects the outer corners of the walls and window openings from mechanical damage and subsequent drying of the finishing layer and allows to make it smooth, neat and beautiful;
- ◇ thanks to the original stretched holes, the angle section is securely and quickly attached to the putty mixture;
- ◇ metal products are made in equal strips: 25x25 mm and 20x20 mm.

Name: AS 20 and AS 25

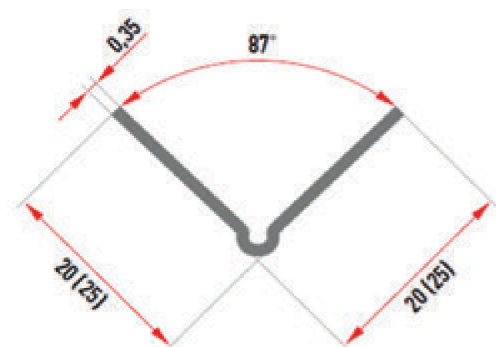
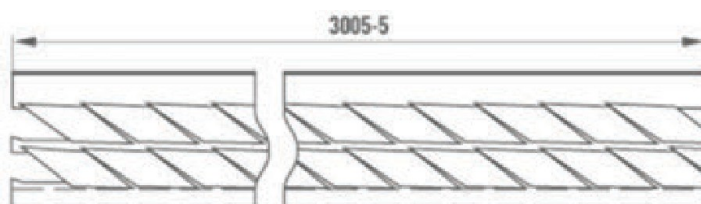



# LIGHTHOUSE SECTION

THE LIGHTHOUSE SECTION IS USED AS A SUPPORT GUIDE WHEN PLASTERING THE SURFACE.

- ◇ sets the thickness of the plaster, which allows to perfectly align the surface;
- ◇ it is indispensable for the automated supply of plaster mixture;
- ◇ it is manufactured in two versions with a working height of 6 and 10 mm.

Name: LSs 20-6 and LSs 20-10

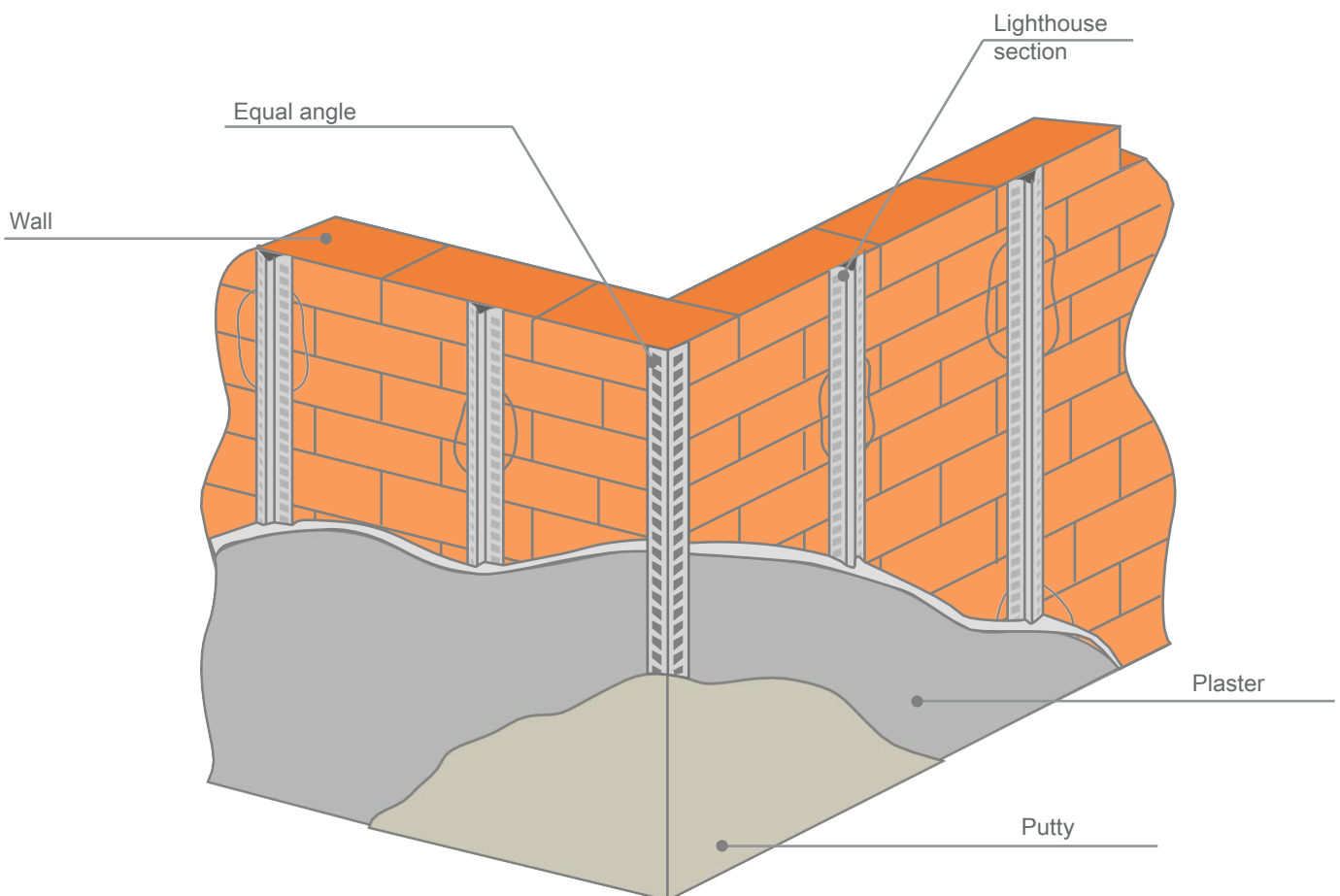
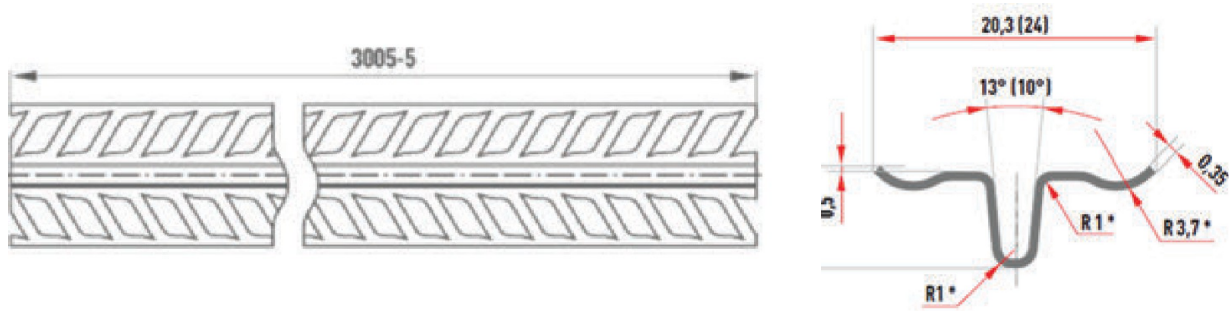

# PRODUCTION CAPABILITIES

NAME	SPECIFICATIONS
Material	Galvanized steel according to GOST R 52246
Metal thickness	0,35 mm
Length of the shape	3 m

NAME	QUANTITY IN A SMALL PACKAGE	QUALITY IN A PACKAGE (FOR A LENGTH OF 3 M)	QUANTITY IN A LARGE PACKAGE
<b>LIGHTHOUSE MESH SECTION</b>			
LSs 20-6-0,35 3M	50 pcs.	150 m	3300 pcs. (66 boxes)
LSs 20-10-0,35 3M	50 pcs.	150 m	3300 pcs. (66 boxes)
<b>EQUAL-FLANGE MESH ANGLE</b>			
AS 20-0,35 3M	50 pcs.	150 m	3600 pcs. (72 boxes)
AS 25-0,35 3M	50 pcs.	150 m	3600 pcs. (72 boxes)

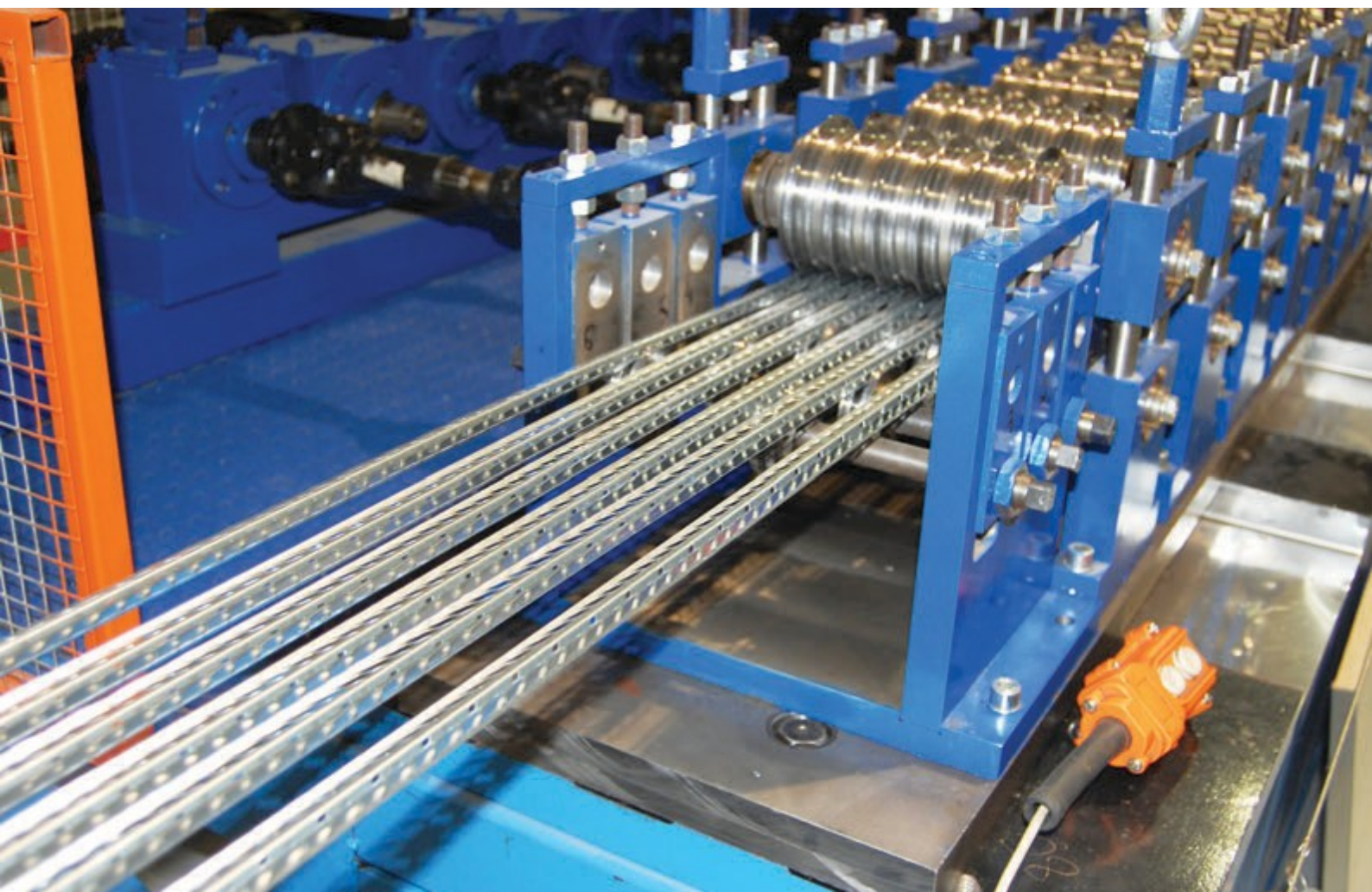



# ROLL-FORMED CHANNEL

"D&POS" MANUFACTURES ROLL-FORMED CHANNEL, IT IS ONE OF THE MOST POPULAR TYPES OF ROLLED METAL, WHICH IS CHARACTERIZED BY **AN OPTIMAL RATIO OF WEIGHT AND STRENGTH.**

**ROLL-FORMED CHANNEL** DIFFERS FROM THE HOT-ROLLED ONE BY THE TWISTED CORNERS AND THE SAME WIDTH OF STEEL THROUGHOUT THE ENTIRE PERIMETER OF THE PRODUCT.



ROLL-FORMED CHANNEL



HOT-ROLLED CHANNEL

THE USE OF ROLL-FORMED CHANNEL ALLOWS TO **SIGNIFICANTLY LIGHTEN THE WEIGHT OF STRUCTURES** AND, ACCORDINGLY, REDUCE THE COST.

## OUR PRODUCTS

- ◇ characterized by ease of installation;
- ◇ have a long life period;
- ◇ omni-purpose;
- ◇ have a relatively small weight;
- ◇ easily tolerate significant axial loads;
- ◇ capable of carrying bending loads;
- ◇ used in metal structures without the use of welding for the installation of the structure;
- ◇ better weldable and other types of processing than hot rolled one;
- ◇ have more accurate overall dimensions;
- ◇ exactly correspond to the thickness of the metal and geometric parameters.

## SCOPE OF APPLICATION

Due to the features of the roll-formed channel, the scope of its application is really very wide and covers many areas of production.

This product is actively used in frame construction, creation of metal structures, manufacturing of metal goods and machinery.

## PRODUCTION CAPABILITIES

NAME	SPECIFICATIONS
Thickness of channel (s)	2,5 – 6 mm
Length	Up to 12 m
Hight of the wall (h)	From 50 to 250 mm
Width of the shelf (b)	From 32 to 125 mm

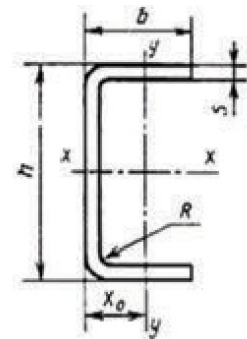

## ADVANTAGES OF WORKING WITH "D&POS"

- ◇ raw material for the manufacture of roll-formed channel is hot-rolled coiled steel of carbon and low-alloy steel grades;
- ◇ input quality control of raw materials in our own laboratory;
- ◇ the steel suppliers are Severstal and NLMK;
- ◇ products are manufactures on a modern Italian equipment in compliance with the requirements of GOST 8278;
- ◇ just-in-time manufacturing;
- ◇ supply from stock and on order;
- ◇ available price;
- ◇ a wide range of dimensional and structural variations.



# FULL CUT EXTENDED MESH

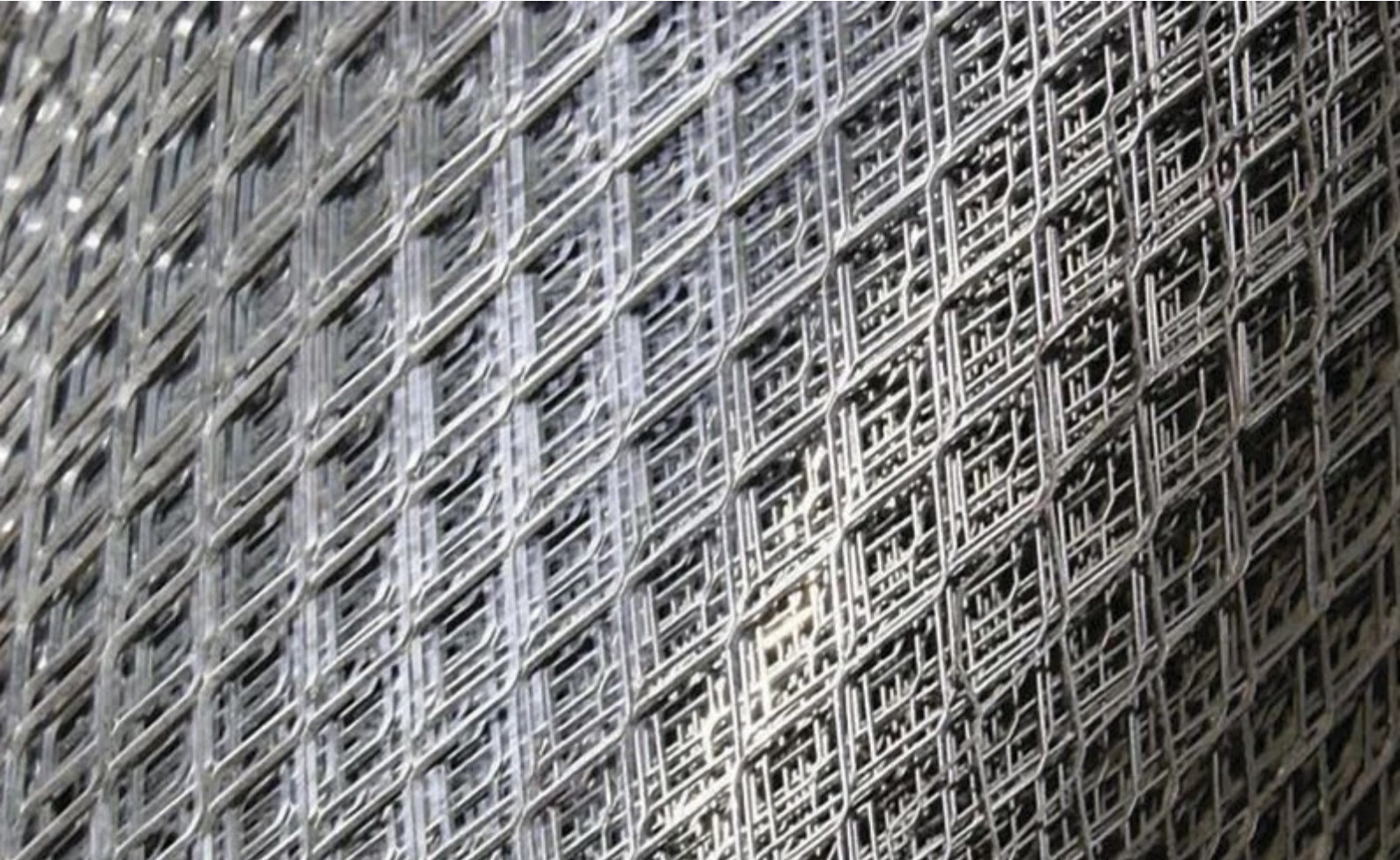

MANUFACTURING OF FULL CUT EXTENDED MESH IS LOCATED IN KRASNODAR KRAI IN A SEPARATE DIVISION "D&POS-GIREY".

**FULL CUT EXTENDED MESH** IS A METAL SHEET, WHICH IS CUT AND STRETCHED INTO DIAMOND-SHAPED CELLS ARRANGED IN A STAGGERED ORDER.



# PRODUCTION CAPABILITIES

NAME	SPECIFICATIONS
Raw material	galvanized sheet, cold-rolled sheet, hot-rolled sheet
Applicable thickness of sheets	from 0.35 mm to 2.0 mm
Sizes of cells	25x10 mm - from sheets with a thickness of 0.35 to 1.0 mm; 50x25 mm - from sheets with a thickness of 0.35 to 1.5 mm; 120x55 mm - from sheets with a thickness of 1.0 to 2.0 mm
The width of rolls	1 000 – 1 250 mm
The length of rolls	5,000 mm and 10,000 mm - standard length, it is also possible to produce rolls of the following length: from 400 mm and 20 000 mm for cells 25x10 mm, from 40 000 mm for cells 50x25 mm and up to 60 000 mm for cells 120x55 mm
Diameter of rolls	5 000 mm – 80 mm 10 000 mm – 100 mm

## ADVANTAGES OF OUR PRODUCTS

**LIGHTNESS.** With a small specific weight (2.5 times lighter than woven, braided and welded), the mesh has an analogous strength.

**TRANSPARENCY.** Freely passes liquids, air, light and sound.

**GOOD ADHESION.** It has a natural three-dimensional structure, which provides high adhesion to almost any surface.

**FLEXIBILITY,** thanks to which it can take almost any form.

**SOLID STRUCTURE.** Even if one of the elements is damaged, the entire canvas does not spread (like a Rabitz type steel-wire plaster fabric), and the strength of the mesh is preserved. It allows to cut products of any necessary form.



## SCOPE OF APPLICATION

The mesh is used in construction as a reinforcing element when performing plastering works, for external and internal finishing, as well as when reinforcing different surfaces. It is also possible to use full cut extended mesh when pouring industrial concrete floors and road surfaces. The material is also widely used in design, in the manufacture of filters and protective covers.



# GRATINGS

- ◇ WELDED GRATINGS
- ◇ PRESSED GRATING
- ◇ CUT PROFILED GRATING
- ◇ STAIRS

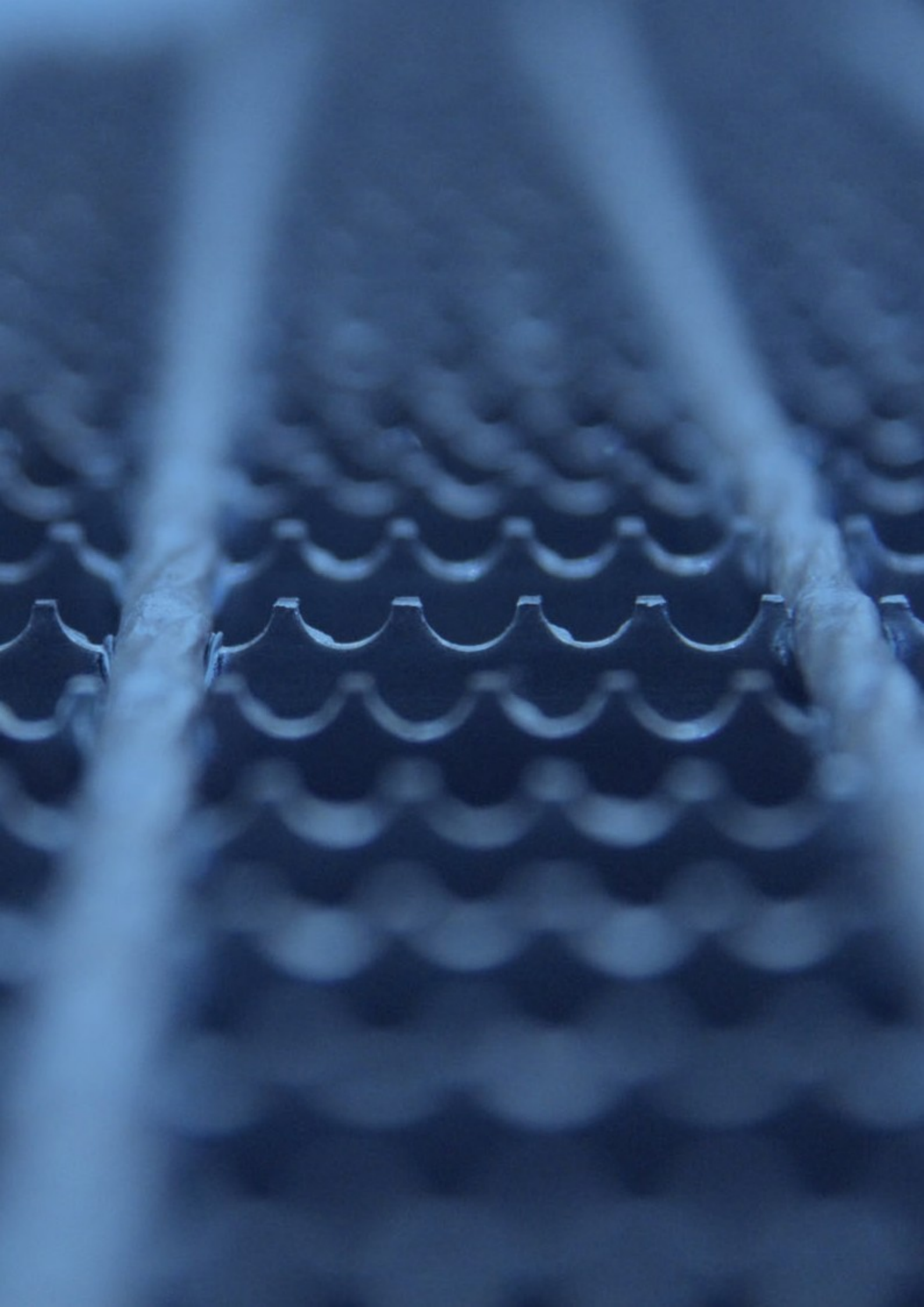



# WELDED GRATINGS



"D&POS" MANUFACTURES  
WELDED GRATINGS ON A HIGH-  
QUALITY EUROPEAN EQUIPMENT.

**WELDED GRATINGS** IS AN INNOVATIVE PRODUCT, WHICH HAS A WIDE APPLICATION IN MODERN INDUSTRIAL AND CIVIL CONSTRUCTION. IT REPRESENTS A LATTICE STRUCTURE CONSISTING OF LOAD-BEARING STRIPS AND CONNECTING RODS CONNECTED AT THEIR INTERSECTION BY CONTACT WELDING UNDER PRESSURE.

# ADVANTAGES OF WELDED GRATINGS

- ◇ high load-bearing capacity (the possibility of movement of loading equipment) and optimal lightness with an equally distributed load (in comparison with all-metal or expanded steel sheets);
- ◇ a convenient and fast way of mounting and dismantling structures without welding, using only fasteners and locksmith tools;
- ◇ aesthetics of appearance, safe operation for the entire period of service;
- ◇ ventilation and light conductivity of structures of multi-level premises (saving on additional lighting and air conditioning of premises);
- ◇ possibility of manufacturing according to individual drawings.

## ADDITIONAL SERVICES

**MANUFACTURING OF STEEL STRUCTURES DETAILS** At the design stage, the specialists of "D&POS" provide services for the layout of the lattice grating on the supporting metal structures according to the sets of drawings of the customer.

**CUTTING TO SIZE, CUTOUTS.** Before the installation stage, we provide services for cutting the grating in size and technological cutouts according to the customer's drawings.

**FRAMING.** We make the framing of the grating both along the ends of the bearing strips and along the connecting elements with a strip and various types of profile: an angle, a pipe, an anti-slip edging.

**PHYSICAL AND MECHANICAL TESTS.** The products are tested for the amount of deflection under axial concentrated and distributed static load in our own laboratory.

**LABELING.** We offer a wide range of variants of labeling of gratings. It is possible to apply labeling not only on bearing and framing strips, but also to individual welded elements.

**PACKAGING.** We provide a variety of different packaging schemes to choose from, depending on the delivery region, transportation method and product storage method.

**PROTECTIVE COVERING.** We provide services for the protection of the surface of the grating from corrosion by methods: hot galvanizing, polymer-powder coating and a combined method.

**DELIVERY.** We provide delivery to all regions of Russia and the CIS countries by our own cars or by rail.

## CERTIFICATION

WELDED GRATINGS MANUFACTURED BY "D&POS" ARE CERTIFIED IN THE SYSTEM OF **GOST R**, WHICH CONFIRMS THE COMPLIANCE OF THE PRODUCT TO THE REGULATORY DOCUMENT **STO 57099372-003**.



# DESIGN FEATURES OF WELDED GRATINGS

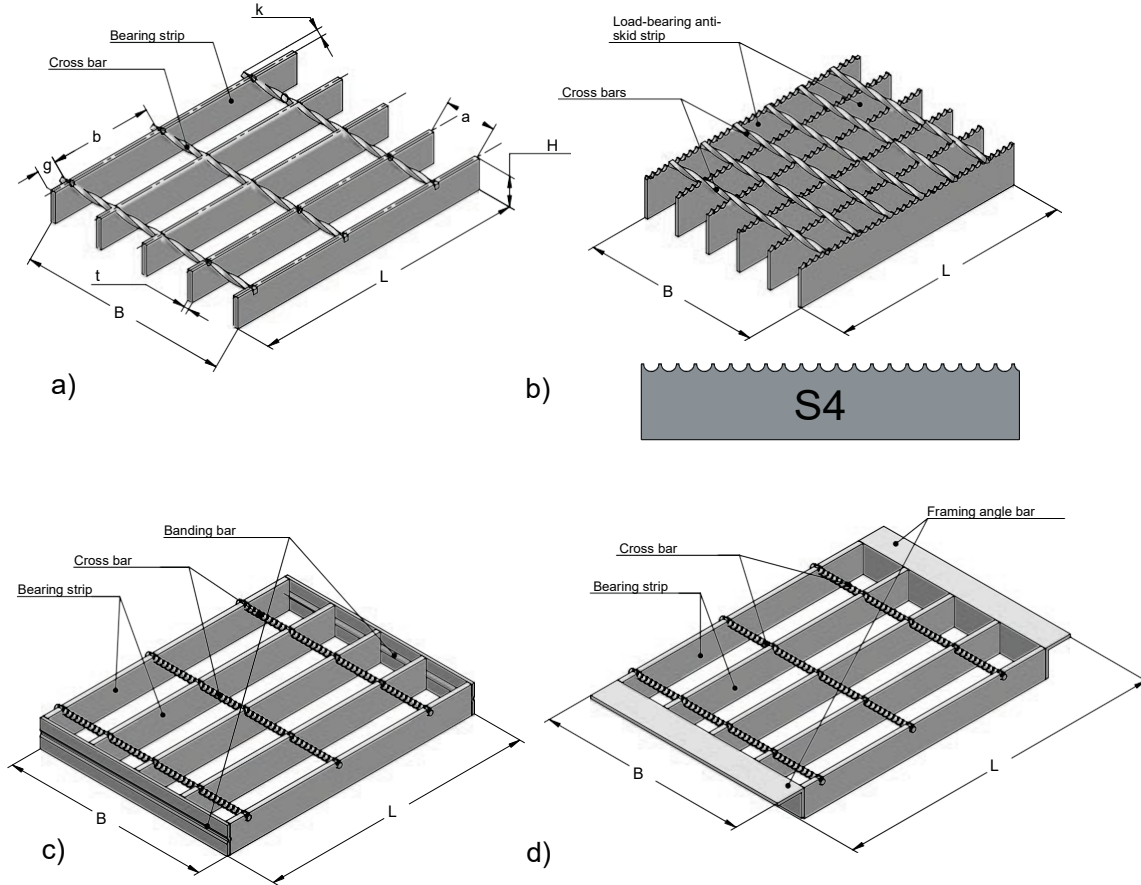

NAME	SPECIFICATIONS
<b>BEARING STRIP</b>	A strip of hot-rolled, hot-rolled pickled, cold-rolled, welded without limitations
Width of the strip	20 – 100 mm
Strip thickness	2 – 8 mm
Pitch of bearing strips	15, 21, 34, 51 and their multiple pitches
<b>CROSS BAR</b>	Twisted square, round cross-section rod, periodic cross-section rod made of hot-rolled, hot-rolled pickled, cold-rolled steels, welded without limitations
Diameter of cross bar	4 – 8 mm
Pitch of cross bars	Stepless with a constant pitch from 19 to 130 mm
<b>GRATING</b>	
Width of the grating *	Up to 1 200 mm
Length of the grating	Up to 8 500 mm

\* - It is possible to manufacture gratings of non-standard sizes.

# VARIANTES OF ANTI-SKID STRIPS

**STRIP WITH TOOTH S4.** The type of grating that is in the greatest demand. Welded gratings with anti-skid strip and tooth S4 is a structure whose bearing strips have semicircular notches on the working surface with a constant frequent pitch forming thin protrusions resembling saw teeth.

This type of bearing strip is characterized by the highest degree of anti-skid according to the international standards DIN 51130.

Areas of application: objects of the gas and oil refining industry, bridge crossings, ladders, towers and observation platforms, service stations, external stairs.

**STRIP WITH TOOTH S5.** Welded gratings with anti-skid strip and tooth S5 offers semi-circular notches on the running surface of the bearing strip with an intermittent pitch. The grating with such strip is characterized with a high level of security.

Area of application: open spaces of industrial facilities, production facilities of the chemical and meat-and-dairy industries.

**STRIP WITH TOOTH S6.** Strip with anti-skid tooth S6 is a strip with trapezoidal sections on the working surface with an intermittent pitch.

Welded gratings with anti-skid strip and tooth S6 is the most popular in shipbuilding industry.

## CERTIFICATION





# APPLICATION OF WELDED GRATINGS

The wide range of applications is due to the unpretentiousness of the grating in maintenance and the reliability of the structures made of them throughout the entire period of operation.

Galvanizing of finished products protects the structure from corrosion and aggressive environmental influences, including sudden temperature changes, as well as an abundance of natural precipitation.

With the help of a variety of mounting options, as well as the ability to produce gratings of non-standard sizes, the installation of structures is possible without the use of cutting and welding tools, and on fire-safe objects without the use of special measures.

## OUR PRODUCTS ARE USED AS:

- ◇ coverings on production sites;
- ◇ fences;
- ◇ stairs;
- ◇ parts of mezzanines in shelving structures;
- ◇ elements of design.





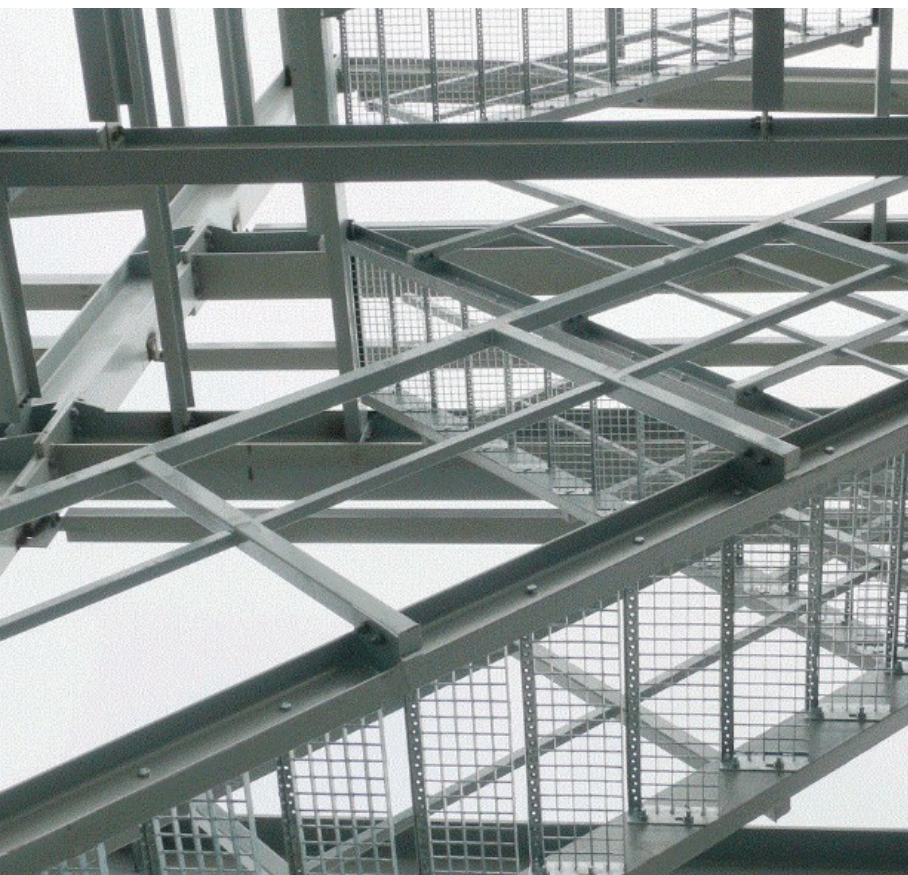



# **PRESSED** GRATING

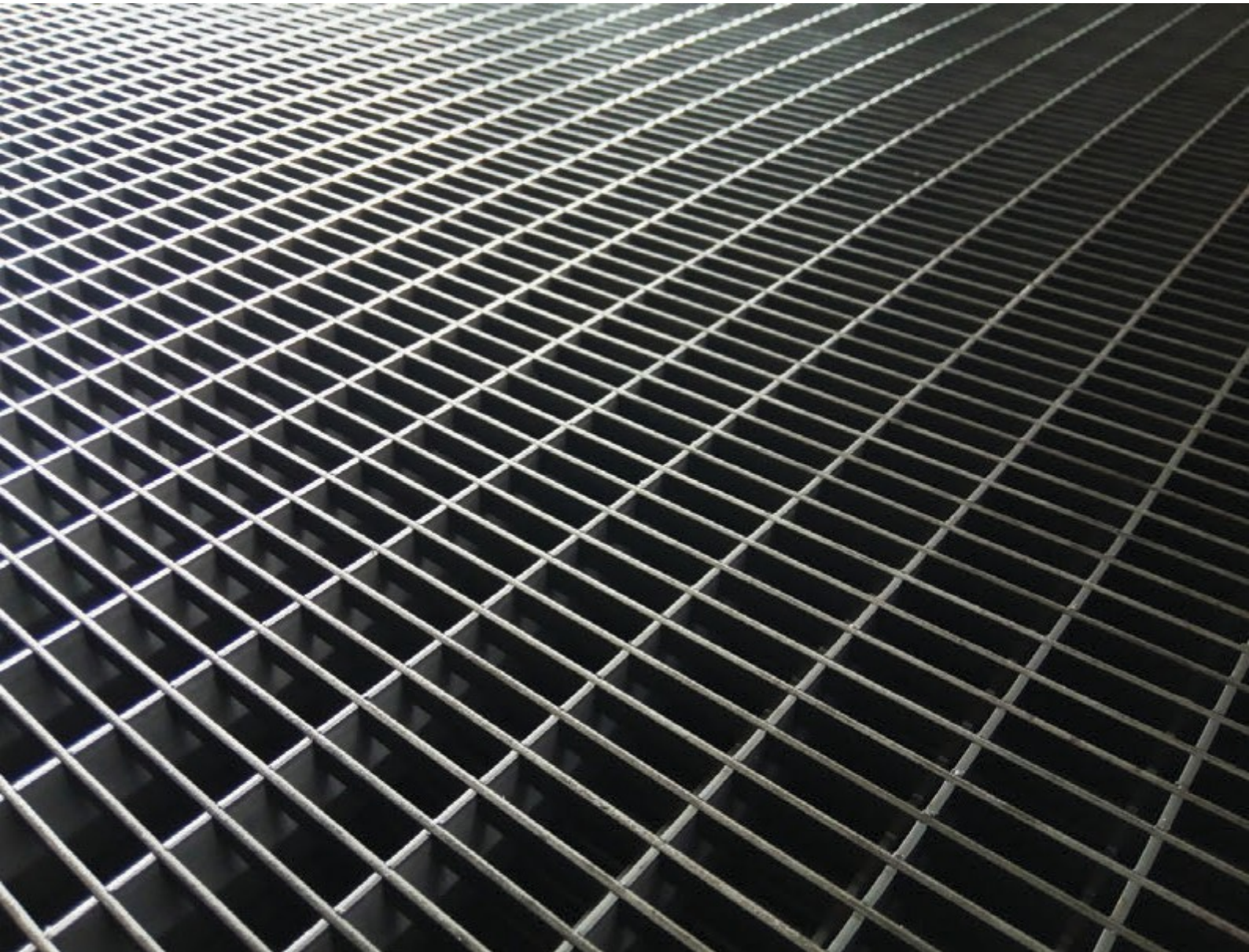

**PRESSED GRATING** IS A OMNI-PURPOSE PRODUCT, WHICH IS USED IN COSTRUCTION, SHIPBUILDING, ARRANGEMENT OF SHOPPING AND OTHER COMPLEXES, IN OTHER AREAS AND SPHERES.

# OUR PRODUCTS

- ◇ are able to withstand high dynamic and static loads, resistant to deformation and mechanical damage;
- ◇ do not lose their properties and characteristics for at least 10 years, while they do not need any special service throughout the entire period of use;
- ◇ manufactured according to the size of the customer;
- ◇ have high anti-skid properties;
- ◇ there is a wide range of execution options;
- ◇ easy to use;
- ◇ fast installation;
- ◇ have an aesthetic appearance;
- ◇ eco-friendly: the grating does not emit substances that are dangerous to health and the natural environment;
- ◇ characterized by high fire resistance indicators.

# PRODUCTION CAPABILITIES

Pressed grating is a grating structure produced using the technology of cold pressing of tie strips into bearing strips under a pressure of over 100 tons. It is possible to manufacture pressed grating out of hot-rolled, cold-rolled and stainless steel.

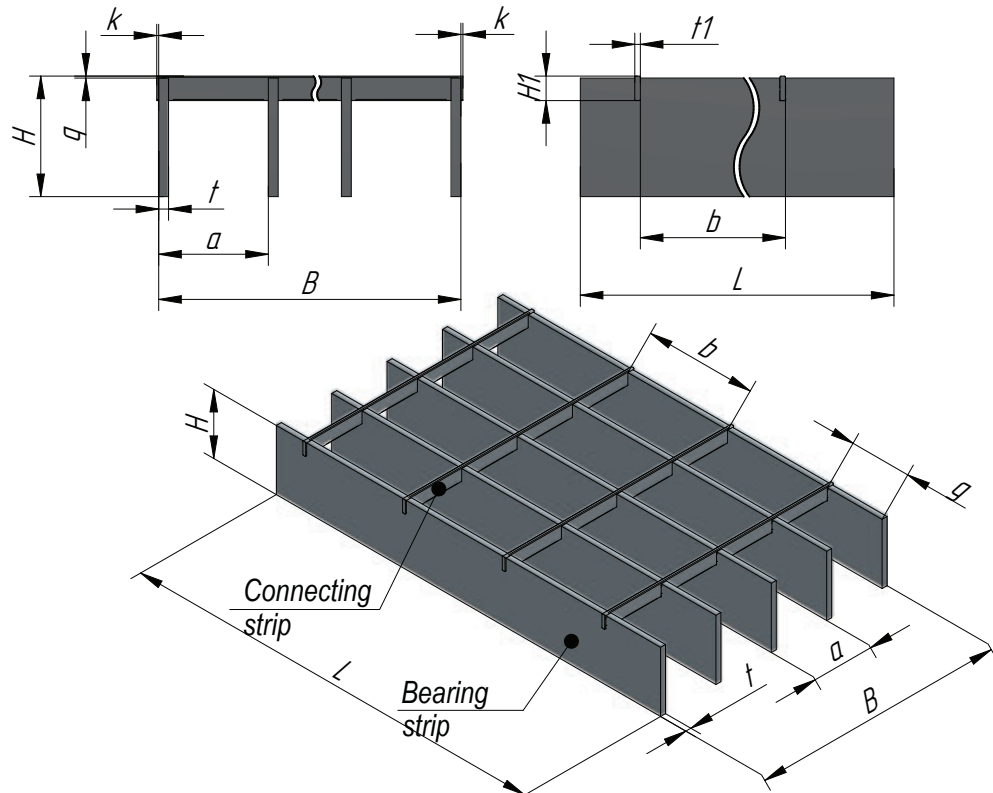

## PRESSED GRATING. MAIN ELEMENTS:

$B$  - the width of the grating (the length of the binding strips),  $L$  - the length of the grating (the length of the binding strips plus framing, if available),  $H$  - the height of the bearing strips,  $t$  - the thickness of the bearing strips,  $a$  - the effective pitch between the bearing strips,  $h_1$  - the height of the binding strips,  $t_1$  - the thickness of the binding strips,  $b_1$  - the pitch between the binding strips,  $k$  - the protrusion of the binding rod,  $g$  - the protrusion of the bearing strip.



NAME	SPECIFICATIONS
<b>BEARING STRIP</b>	Strip from hot-rolled, hot-rolled pickled, cold-rolled steel, welded without limitations
Width of the strip	20 – 50 mm
Strip thickness	2, 3 mm
Pitch of bearing strips	11, 22, 33, 44, 55 and 66 mm
<b>CROSS BAR</b>	Strip from hot-rolled, hot-rolled pickled, cold-rolled steel, welded without limitations
Pitch of cross bars	11, 22, 33, 44, 55 and 66 mm
<b>GRATING</b>	
Width of the grating along the connecting strip *	Up to 4 000 mm
Length of the grating along the bearing strip *	Up to 1 500 mm

\* - It is possible to manufacture gratings of non-standard sizes.

## SCOPE OF APPLICATION

Due to the lattice structure, the pressed grating has many unique properties that are indispensable when using it as a floor covering. The surface of such a floor has a reliable grip, liquid does not accumulate on it. High strength and competent selection of cell sizes can protect the floor from the accumulation of, for example, sawdust and small metal shavings on it.

The high load-bearing capacity allows the pressed gratings to be used even in heavy industry.







## ADVANTAGES OF WORKING WITH "D&POS"

- ◆ Products are manufactured on a **high-tech European equipment**.
- ◆ At the design stage, the specialists of "D&POS" provide services for the development of **steel structures details**, the layout of the pressed grating on the supporting metal structures according to the sets of drawings of the customer.
- ◆ Before the installation stage, we provide services for **cutting the gratings in size and technological cutouts** according to the customer's drawings.
- ◆ We make the **framing of the grating** both along the ends of the bearing strips and along the connecting elements with a strip and various types of profile: an angle, a pipe, an anti-slip edging.
- ◆ We offer a wide range of variants of **labeling of grating**.
- ◆ We provide services for the **protection of the surface of the grating from corrosion** by methods: hot galvanizing, powder painting and a combined method.
- ◆ The products are **tested for the amount of deflection under axial concentrated and distributed static load in our own laboratory**.
- ◆ We provide a variety of different **packaging schemes** to choose from, depending on the delivery region, transportation method and product storage method.
- ◆ We provide **delivery** to all regions of Russia and the CIS countries by our own cars or by rail.





# PROFILE PLATFORM GRATING

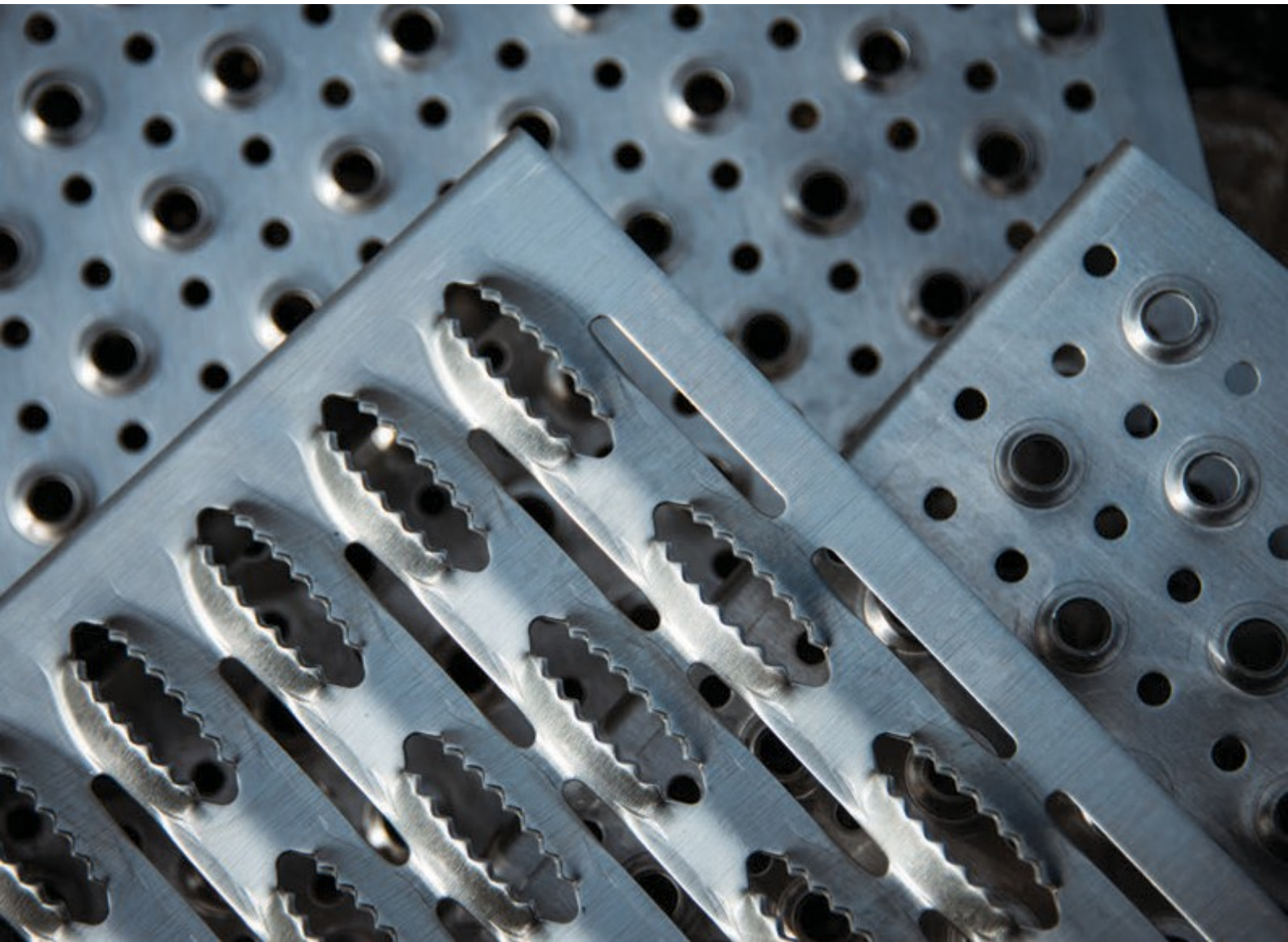

**PROFILE PLATFORM GRATING** IS A FLOORING GRID THAT HAS A UNIQUE ANTI-SLIP SURFACE AND IS CHARACTERIZED BY A HIGH ABILITY TO MAINTAIN ITS PROPERTIES EVEN IN PARTICULARLY UNFAVORABLE OPERATING CONDITIONS.

# ADVANTAGES OF PROFILE PLATFORM GRATING

- ◇ anti-slip, which is provided by holes of various configurations and types of faces;
- ◇ holes on the grating do not allow liquids and natural precipitation to linger on its surface;
- ◇ aesthetic appearance of the surface made of cut profiled grating allows it to be used in urban infrastructure and civil construction;
- ◇ a large number of holes reduces the weight of the grating, thereby ensuring the lightness of the finished structure;
- ◇ grating structures are omni-purpose and can be used in conditions of various temperature conditions, humidity levels and external chemical influences;
- ◇ cut profiled grids are manufactured from various materials that make them highly resistant to corrosion and increase their longevity.

## "CLOSED" PROFILE PLATFORM GRATING

The very name of this type of cut profiled grating, "Closed", indicates that this grating does not have through holes along the entire working surface of a separate element.

Its key advantage is safety and the creation of a covering with a minimal "grater" effect, which will be especially important in places where children may appear and where it is necessary to provide a non-slip covering with a low intensity of contamination.

Due to the protruding blind punching, the ingress of, for example, sand on such a surface will not reduce friction and maintain good adhesion to the surface.

**APPLICATION:** PASSAGES AND TRAFFIC AREAS ON STREET SITES, FACADES.

## PRODUCTION CAPABILITIES

NAME	SPECIFICATIONS
Type of grating	Closed
Material	Carbon, galvanized and stainless steel, aluminium
Thickness	1,5 / 2,0 / 2,5 mm
Protective covering	Hot zinc according to GOST 9.307
Maximum length of the workpiece	3 000 mm
Width of the grating	150, 200, 250, 300, 400 mm
Hight of the grating	40, 50, 75 mm

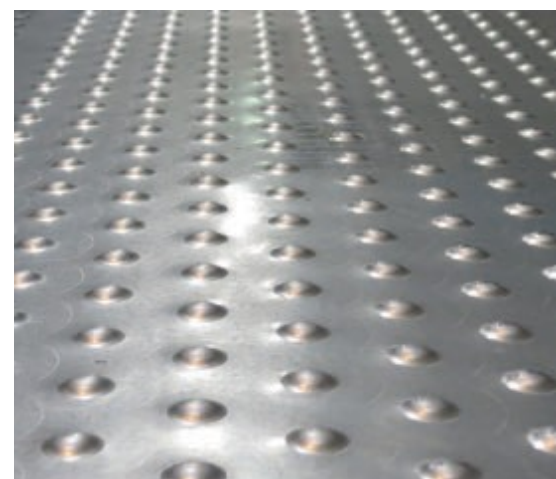

\* - It is possible to manufacture gratings of non-standard sizes.



# JAGGED PROFILE PLATFORM GRATING

This type of cut profiled grating has oval perforated holes with jagged edges on the entire working surface. Thanks to such a sawtooth shape of the protruding edges of the working surface of the gratings, they have the highest anti-slip ability in comparison with other types.

This type of grating is most often used as platforms in order to ensure uniformity of route communication. Additional perforation on the working surface reduces the area where contamination can remain, and the protruding faces contribute to the breaking and crushing of large waste elements.

Jagged grating is perfect for use where there may be increased contamination or sticking of large particles, such as clay, snow.

**APPLICATION:** CONSTRUCTION SITES, CROSSINGS, OVERPASSES.

## PRODUCTION CAPABILITIES



NAME	SPECIFICATIONS
Type of grating	Jagged
Material	Carbon, galvanized and stainless steel, aluminum
Thickness	1,5 / 2,0 / 2,5 mm
Protective covering	Hot zinc according to GOST 9.307
Maximum length of the workpiece	3 000 mm
Width of the grating	120, 180, 240, 300, 360, 420, 480 mm
Hight of the grating	40, 50, 75 mm

\* - It is possible to manufacture gratings of non-standard sizes.

# ROUND PROFILE PLATFORM GRATING

This type of the grating has averaged parameters of resistance to dirt and anti-slip properties. The protruding element alternates with perforation both along and across the sheet.

Thanks to the averaged parameters, it is possible to operate at industrial and civil facilities with an average intensity of contamination with liquid and bulk compositions.

**APPLICATION:** PASSAGES, STAIRS, SCAFFOLDING.

## PRODUCTION CAPABILITIES

NAME	SPECIFICATIONS
Type of grating	Round
Material	Carbon, galvanized and stainless steel, aluminium
Thickness	1,5 / 2,0 / 2,5 mm
Protective covering	Hot zinc according to GOST 9.307
Maximum length of the workpiece	3 000 mm
Width of the grating	150, 200, 250, 300 mm
Hight of the grating	40, 50, 75 mm



\* - It is possible to manufacture gratings of non-standard sizes.

## RAMP CUT PROFILED GRATING

A characteristic feature of this type of cut profiled grating is oval perforated holes transverse to the entire width of the lattice with the edges wrapped inside. They alternate with round holes across the grating.

The features of this type include large through "windows" for fairly large particles of waste or natural precipitation.

This type of grating can be used in woodworking shops, where the amount of wood chips and waste is sufficiently voluminous, and thanks to large transverse holes, the surface of the grating will remain clean of permanent objects.

**Ramp cut profiled grating has a less "aggressive" working surface in comparison with jugged cut profiled grating.**  
**APPLICATION:** PRODUCTION SITES, RAMPS, STORM WATER CHANNELS.

## PRODUCTION CAPABILITIES

NAME	SPECIFICATIONS
Type of grating	Ramp
Material	Carbon, galvanized and stainless steel, aluminium
Thickness	1,5 / 2,0 / 2,5 mm
Protective covering	Hot zinc according to GOST 9.307
Maximum length of the workpiece	3 000 mm
Width of the grating	150, 200, 250, 300 mm
Hight of the grating	40, 50, 75 mm



\* - It is possible to manufacture gratings of non-standard sizes.



# STAIRS FROM GRATING

## **STAIRS FROM GRATING**

ARE PRODUCED AT THE "D&POS"'S OWN PRODUCTION. STAIRS HAVE AN ANTI-SKID EDGE AND SIDE LININGS WITH HOLES FOR ATTACHING THE STAIRS TO THE SKEWERS OR OTHER ELEMENTS OF THE STAIRCASE STRUCTURE.



THE STAIRS ARE SUBJECT TO **HIGHER REQUIREMENTS IN TERMS OF TRAFFIC SAFETY**, SO ALL STAIRS ALWAYS HAVE AN ADDITIONAL **ANTI-SKID EDGE**.

## TYPICAL TYPE OF STAIRS

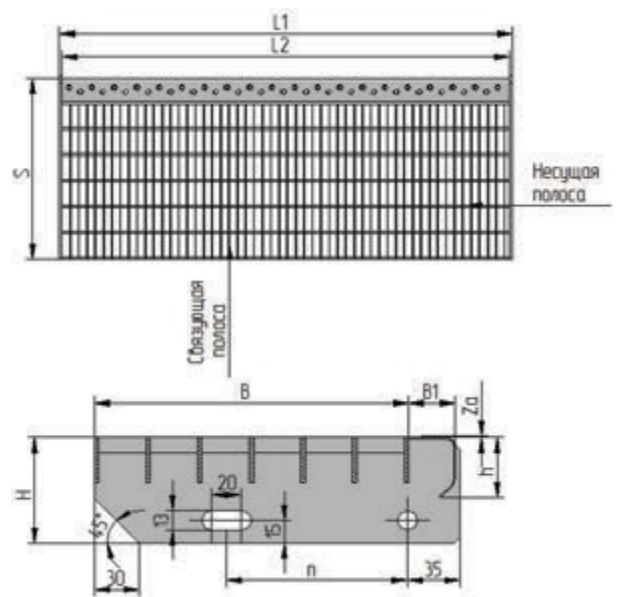
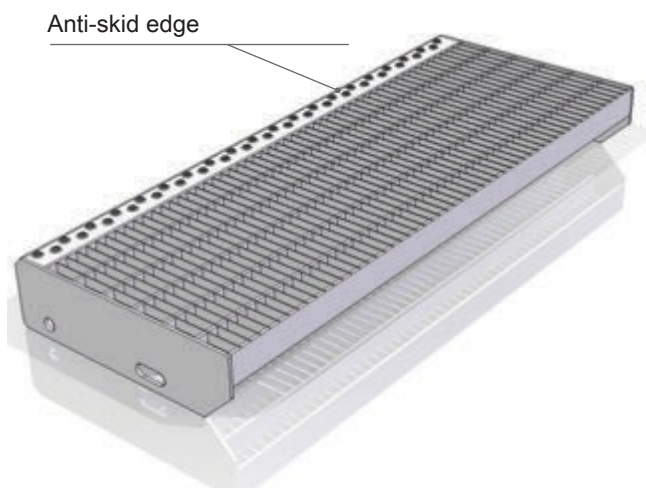

### DESIGNATIONS:

L1 - the length of the stairs, L2 - the length of the anti-skid edge, S - the depth of the stairs, B - the width of the grating, H - the height of the stairs, B1 - the width of the anti-skid edge, h - the height of the anti-skid edge, Za - the height of the bulge of the opening of the anti-skid edge, n - the center fixing distance

The stairs can be made individually for the project or to the technical requirements of the customer.



## SCOPE OF APPLICATION

The stairs from grating is an excellent solution for industrial facilities, enterprises of the oil and gas and agroindustrial complex, in civil construction and other industries where there is a risk of slipping. The presence of an anti-skid edge provides increased safety when moving, reduces the likelihood of a person falling, and also creates additional stability against the deflection of the stairs.



# STAIRS FROM PROFILE PLATFORM GRATING



STAIRS ARE MANUFACTURED FROM ALL TYPES OF PROFILED GRATINGS. THEY DIFFER FROM THE CUT PROFILED GRATING BY THE PRESENCE AT THE ENDS OF THE MOUNTING PLATE WITH HOLES FOR MOUNTING TO STRUCTURAL ELEMENTS. THE MOUNTING PLATE CAN BE EITHER BELTED OR WELDED OR SECURED TO THE GRATING WHEN MOUNTING WITH A BOLTED CONNECTION.

THE LENGTH OF STAIRS IS RECOMMENDED TO BE CHOSED FROM THE STANDARD SIZE RANGE OF STEP LENGTHS: **600, 700, 800, 900, 1000, 1100 And 1200 MM.**

## FEATURES OF THE CONSTRUCTION OF STEPS MADE OF PROFILE PLATFORM GRATING

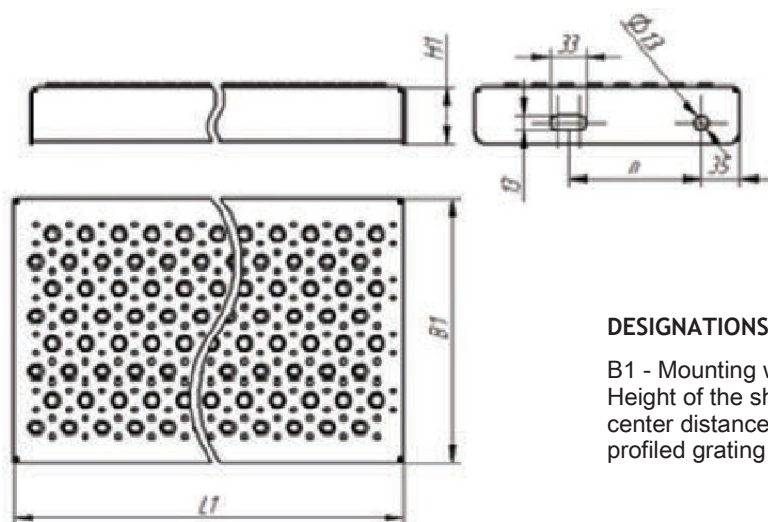

### DESIGNATIONS:

B1 - Mounting width of the cut profiled grating, H1 - Height of the shelf of the cut profiled grating, n - center distance for fastening, L1 - Length of the cut profiled grating

NAME	SPECIFICATIONS
Mounting width of the grating	150, 200, 300 mm
Height of the shelf	40, 50, 75 (70 for stairs with welded mounting bar) mm
Center distance for fastening	90, 120, 150, 180 mm
Length	600, 800, 1 000, 1 200 mm



## STAIRS FROM "CLOSED" PROFILE PLATFORM GRATING

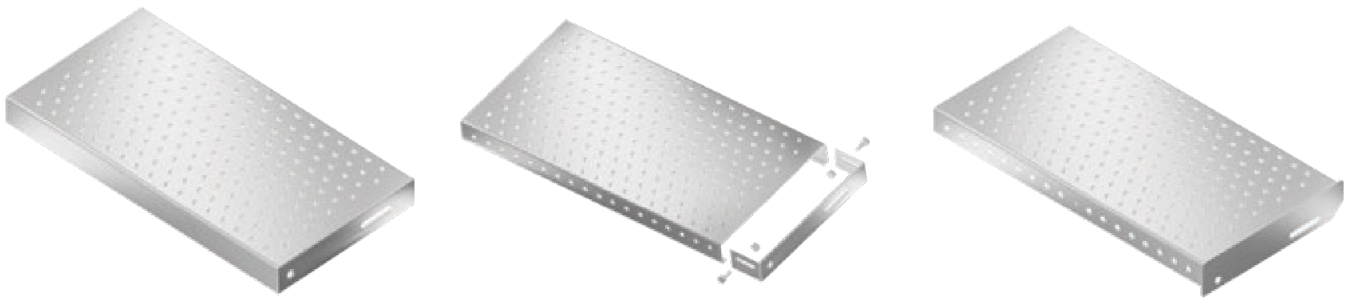

Stairs made of profiled gratings of the "Jugged" type are used to cover passages and traffic areas on street platforms where a non-slip coating is necessary at a low pollution intensity.

## STAIRS FROM "JAGGED" PROFILE PLATFORM GRATING



The most popular type of stairs from the cut profiled gratings. They are used on construction sites, crossings, overpasses, where it is possible for large particles such as clay and snow to stick.

## STAIRS FROM "ROUND" PROFILE PLATFORM GRATING

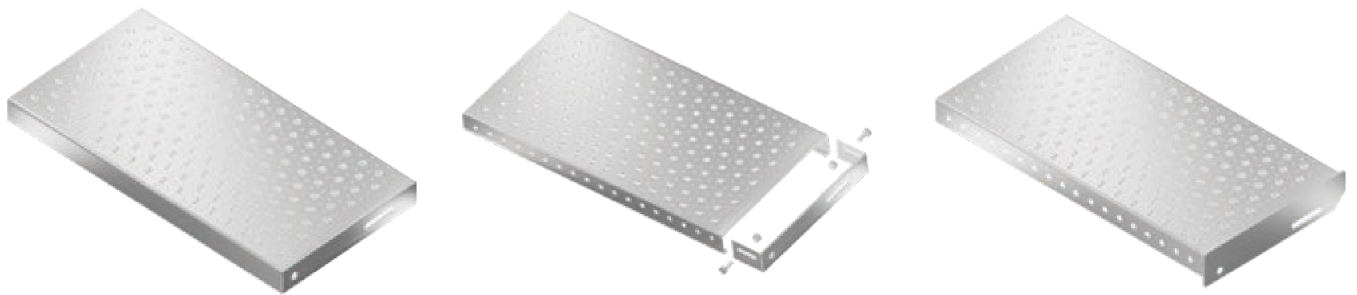
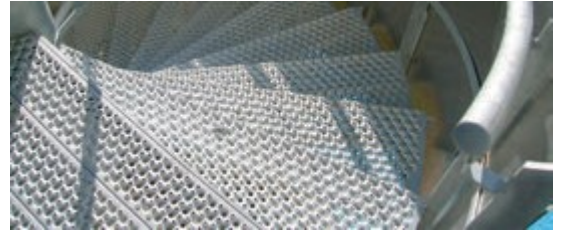

This type of stairs from the cut profile gratings is used at various crossings, scaffolding and other objects with a low intensity of contamination with bulk compounds.

## STAIRS FROM "RAMP" PROFILE PLATFORM GRATING

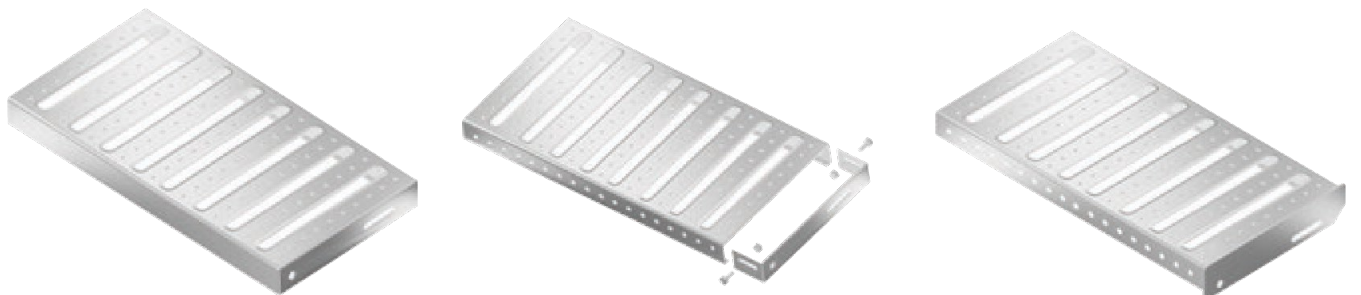

It is used in the manufacture of stairs for production sites, ramps and other objects, where the amount of contamination falling on the stairs can be quite voluminous, and large transverse openings of the grating allow the structure to remain clean of foreign objects.



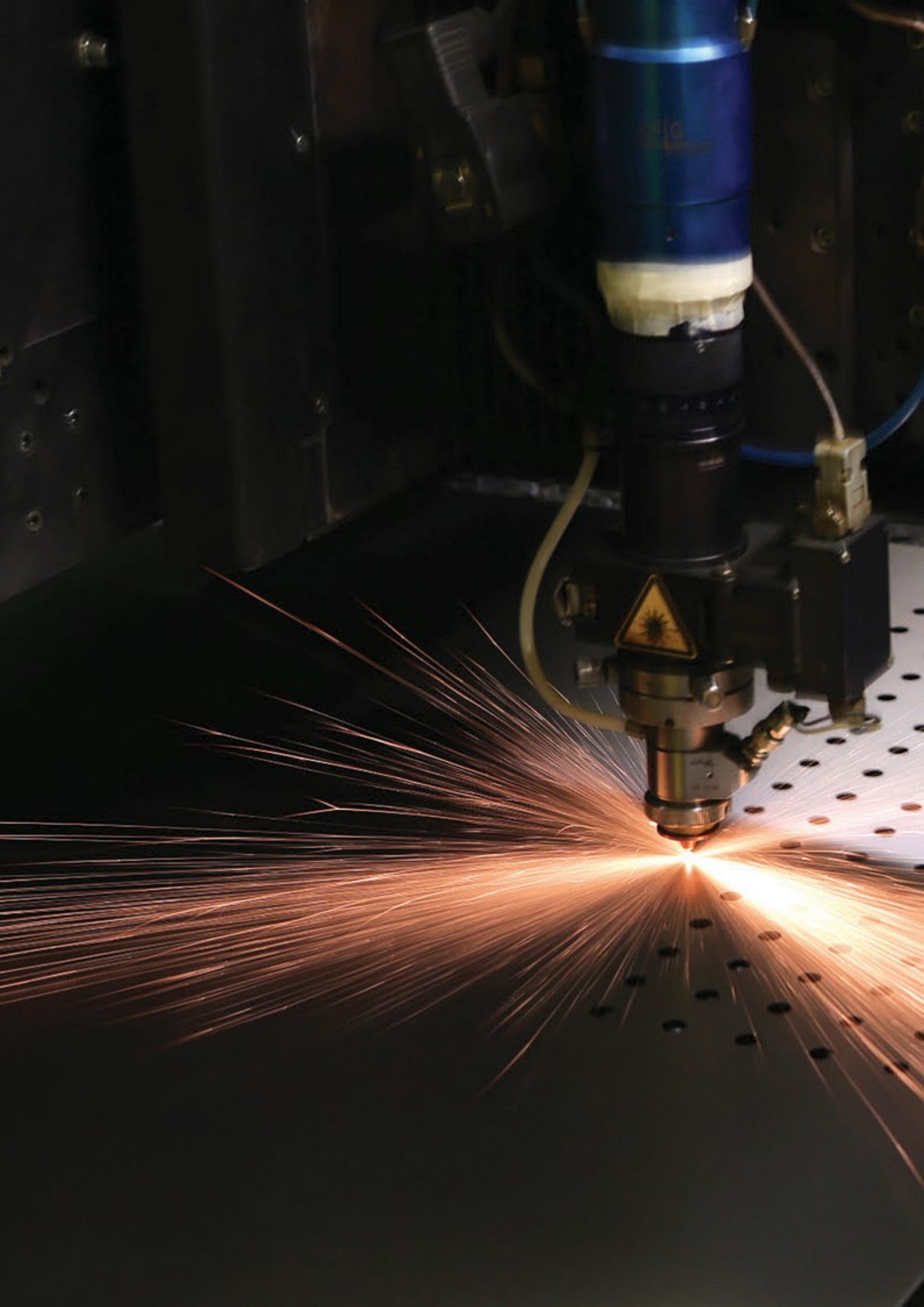

# SERVICES

- ◇ PROTECTIVE COVERING
- ◇ PHYSICAL AND MECHANICAL TESTS
- ◇ LASER CUTTING
- ◇ PLASMA ARC CUTTING
- ◇ SHEET PUNCHING
- ◇ METAL FORMING
- ◇ ENGINEERING CENTER
- ◇ DELIVERY
- ◇ SCRAP RECYCLING



# PROTECTIVE COVERING

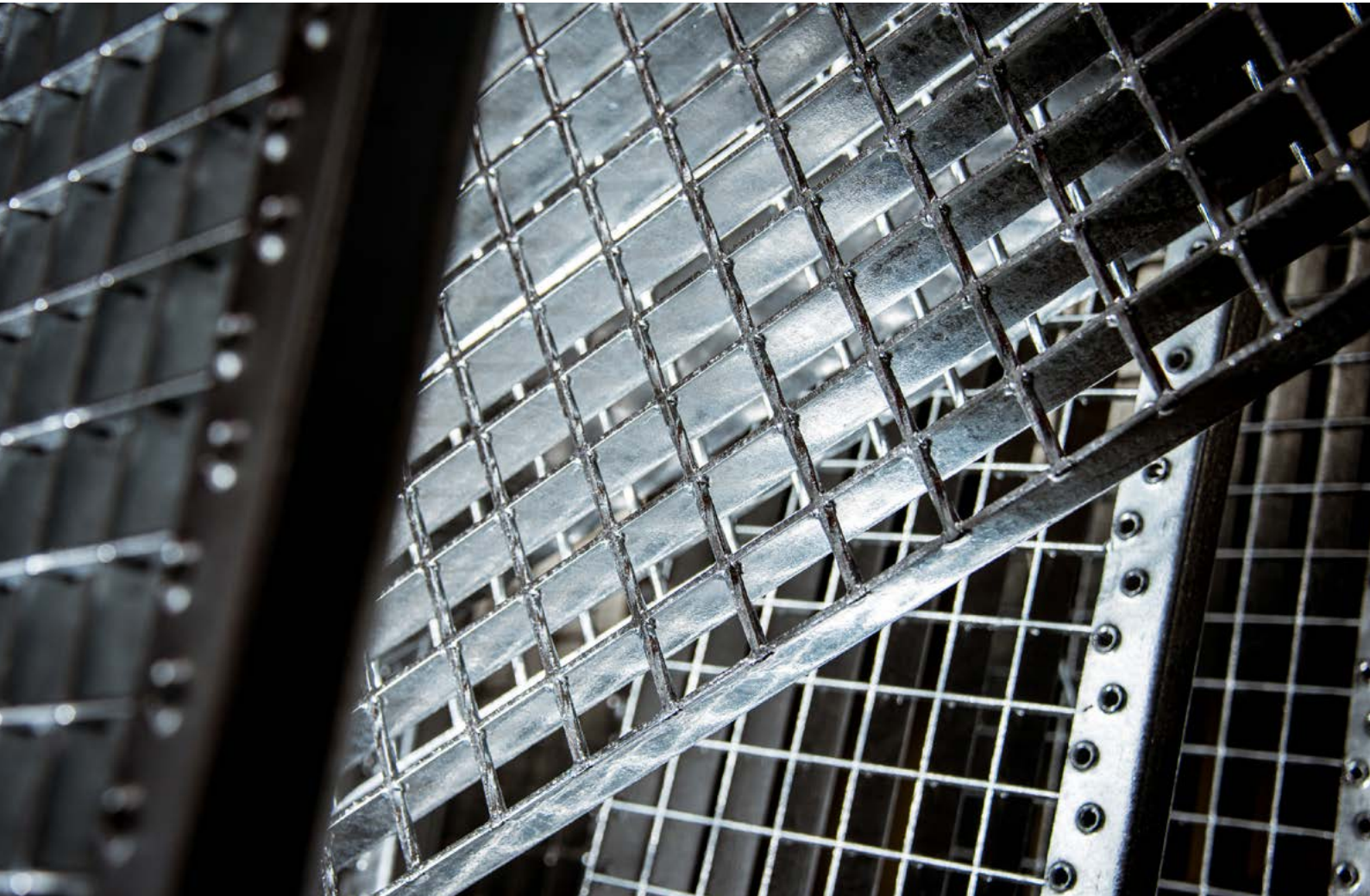

THE MAIN GOAL OF THE **PROTECTIVE COVERING** IS TO PREVENT THE CORROSIVE

EFFECT OF THE EXTERNAL ENVIRONMENT ON METAL STRUCTURES, AS A RESULT OF WHICH RUST APPEARS, WHICH NEGATIVELY AFFECTS NOT ONLY THE APPEARANCE, BUT ALSO THE LONGEVITY OF STEEL PRODUCTS.

"D&POS" OFFERS THE FOLLOWING TYPES OF THE PROTECTIVE COVERING FOR GRATINGS AND STAIRS OF ITS OWN PRODUCTION: HOT GALVANIZING, POWDER PAINTING, AS WELL AS THE COMBINED METHOD THAT COMBINES HOT GALVANIZING WITH THE SUBSEQUENT PAINTING.



# HOT-DIP GALVANIZING

## DIMENSIONS OF LOADING INTO THE GALVANIZING BATH:

Length - 6 000 mm or 6 500 mm depending on the type of the lifting bar;  
Width - 1 100 mm;  
Depth - 2 200 mm.

## ADVANTAGES OF HOT GALVANIZING

- ◇ durable covering, resistant to mechanical effects;
- ◇ the minimum thickness of zinc, which practically does not weigh down the structure;
- ◇ quality control of finished products in our own laboratory;
- ◇ environmental friendliness and complete safety of the structure for the environment.





# ELECTROLYTIC ZINCING

"D&POS" offers electrolytic zincing of products of its own production. It is one of the most common methods of creating anticorrosive and decorative zinc coverings.

## FEATURES OF ELECTROLYTIC ZINCING

- ◇ galvanized covering does not form intermediate iron-zinc alloys with the base metal, as with hot galvanizing, nevertheless adhesion is quite high;
- ◇ galvanized coverings have a more thin structure;
- ◇ it is possible to adjust thickness of the received coverings;
- ◇ the method does not involve the use of high temperatures;
- ◇ the method uses DC;
- ◇ the main disadvantage is the unevenness of the resulting coverings on products of a complex profile;
- ◇ the method makes it possible to obtain zinc coverings of a significantly smaller thickness (up to 24 microns) compared to the "hot" method, which affects the period of life of products.

## POWDER POLYMER COVERING

"D&POS" protects the surface of manufactured products with the help of powder painting. This service is available when ordering products of our own production.

This method protects the main metal products produced at our production from corrosion. These include various profiles (angle section, roll-formed channel, open section), grating (profiled, pressed, cut profiled, expanded steel sheet), laser details (profiles, boxes) and other small welded metal structures.



# ADVANTAGES OF POWDER COVERINGS COMPARED TO SOLVENT-BASED PAINTS

- ◇ excellent decorative and physicochemical properties of coverings, unattainable with traditional methods of painting;
- ◇ higher quality of coverings and better performance properties are achieved;
- ◇ covering of the products is carried out without priming the surface;
- ◇ due to the 100% dry matter content, the powder covering is applied in one layer, unlike expensive multi-layer liquid coverings;
- ◇ porosity in the powder covering is much less. Most powder paints have improved anti-corrosion and impact-resistant properties compared to conventional paints;
- ◇ no special preparation or viscosity control is required for powder covering, since powder paints are supplied to the consumer in a ready-to-use form;
- ◇ losses in powder covering are only 1-4%, while the losses in liquid paint are about 40%;
- ◇ solidification of the powder covering takes place within just 30 minutes;
- ◇ high strength of the powder covering minimizes damage to the painted products during transportation, in addition, it reduces packaging costs.



## COMBINED COVERING

"D&POS" offers services for the application of a combined covering "zinc-polymer", the main advantage of which is to increase the service life of the anticorrosive covering in comparison with the classic types.

The combined covering is achieved by the joint interaction of hot galvanizing and powder covering systems. In the world, this method is known as a duplex system, which has proven itself well in industrial areas where metal corrosion protection is especially important.

This system of covering has a synergistic effect, which consists in the fact that powder painting slows down the speed of zinc consumption. In turn, if the polymer covering layer is damaged, zinc protects the metal. As a result, the metal structure is provided with protection for the validity period from 1.5 to 2.3 times higher than the sum of the validity periods of the protection of each anti-corrosion system separately.



# PHYSICAL AND MECHANICAL TESTS



## AREA OF ACTIVITY OF THE LABORATORY

Since 2006, the laboratory of Verkhnevolzhsky SMC has been carrying out input control of mechanical properties, chemical composition and other parameters of raw materials; technological tests of fittings, wires, welded meshes, gratings and welded pipes at the request of all services of the enterprise, branches of "D&POS", as well as under contracts and demands of third-party consumers.

In 2020, the laboratory section, located in the building of the workshop for the production of profiled gratings, started working. It is equipped with a specialized equipment for testing the grating produced at the enterprise for the amount of deflection under axial concentrated and distributed static load.

## MAIN TYPES OF TESTED RAW MATERIALS

- ◇ cold-rolled and hot-rolled sheets, thickness from 0.20 to 6.0 mm, with and without coverings;
- ◇ wires and fittings with a diameter of 2.8 to 14.0 mm.

# TYPES OF TESTS CONDUCTED IN ACCORDANCE WITH GOST AND EUROPEAN STANDARDS:

- ◇ determination of the time resistance, yield strength, relative elongation of the coefficient of normal anisotropy and the coefficient of deformation hardening;
- ◇ determination of the chemical composition in iron and zinc-based alloys (by spectral method);
- ◇ bending tests of metals;
- ◇ determination of the depth of a spherical well using the Eriksen method;
- ◇ determination of surface roughness;
- ◇ testing of cross-shaped joints of welded meshes for tension, shear and bending;
- ◇ determination of hardness by Rockwell, Super-Rockwell and Brinell;
- ◇ determination of the characteristics of polymer paint and varnish coverings applied to cold-rolled, galvanized sheet (thickness, adhesion, reverse impact strength, bending strength, hardness, tensile strength);
- ◇ determination of the impact strength of the metal;
- ◇ tests of electric-welded pipes for distribution, flattening and bending;
- ◇ tests of gratings for deflection by distributed and concentrated load.

For all these tests, the laboratory has a sufficient number of verified measuring instruments, test and auxiliary equipment.

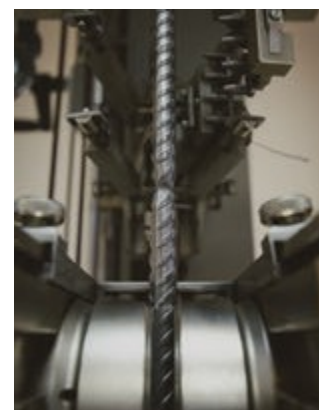

## DOCUMENTS

Certificate of the state of measurements of the Laboratory of LLC "Verkhnevolzhsky SMC" No. 19/138 of the Federal State-Funded Institution "Ivanovo CSM".

Certificate of recognition of the competence of the testing laboratory of LLC "Verkhnevolzhsky SMC" No. FTS RU. I1447. 22IL15 in the System of voluntary certification in construction in the Russian Federation "FTS-stroy-certification".



# LASER CUTTING



**LASER CUTTING** IS A HIGH-TECH METHOD OF CUTTING MATERIALS BASED ON THE IMPACT OF A FOCUSED LASER BEAM, WHICH IS USED FOR PROCESSING VARIOUS PRODUCTS AND DOES NOT REQUIRE SIGNIFICANT MATERIAL COSTS, PROVIDING HIGH QUALITY PROCESSING WITHOUT MECHANICAL IMPACT ON THE MATERIAL.

## SCOPE OF APPLICATION

- ◇ creation of elements or drafts from a certain type of material in various spheres of industry and construction;
- ◇ advertising products: various kinds of signs, elements of three-dimensional letters, details of commercial equipment;
- ◇ decorative elements that are used in interior advertising or to create an original interior design;
- ◇ information signs.



# ADVANTAGES OF LASER CUTTING

- ◇ achieving high cutting accuracy without errors and with minimal tolerances;
- ◇ low cost and high speed of manufacturing of products of complex shapes;
- ◇ absence of mechanical impact on the processed material, respectively, minimal deformations;
- ◇ possibility of processing mirror and polished surfaces;
- ◇ savings in the production of prototypes of metal products: laser cutting helps to avoid the cost of manufacturing complex molds for pressing and casting;
- ◇ minimal human involvement, thanks to this - minimal errors when cutting metal;
- ◇ the process of processing the material takes little time, even in the case of high complexity of the work;
- ◇ possibility of engraving allows you to apply designations, labels and text on a metal surface.

## PRODUCTION CAPABILITIES

NAME	SPECIFICATIONS
Parameters of the raw material	Thickness from 0.4 to 16 mm: <ul style="list-style-type: none"> <li>◇ inox – up to 8 mm;</li> <li>◇ aluminium – up to 6 mm;</li> <li>◇ brass – up to 4 mm;</li> <li>◇ copper – up to 2 mm.</li> </ul>
Maximum dimensions of the workpiece	1 500 x 3 000 mm
Maximum weight of the workpiece	500 kg

**Processed materials:** galvanized steel, carbon steel, stainless steel, aluminum, brass, copper.

Our equipment allows to carry out laser cutting of even easily deformable and non-rigid workpieces and parts with a high level of accuracy. That is why, in addition to cutting sheet metal, laser engraving is also performed to apply a drawing of any detail and complexity to the metal surface.

## WE OFFER

- ◇ cutting of metal with various thermal characteristics: stainless steel, aluminum, brass, copper, etc.;
- ◇ 5 laser processing machines: ytterbium-fiber laser installations with a capacity of 2 kW, 3 kW and 5 kW;
- ◇ manufacturing of metal sheets of the required size on our own slitting and cross-cutting lines from rolled steel, which allows to minimize waste and offer the customer a low price;
- ◇ consistent cut quality, which is ensured by the stability of the fiber laser beam parameter;
- ◇ parts of various shapes and thicknesses - gears, washers, fasteners and others;
- ◇ technological matrices with difficult-to-produce contours, stencils, souvenirs, ornaments and patterns.



# PLASMA ARC CUTTING

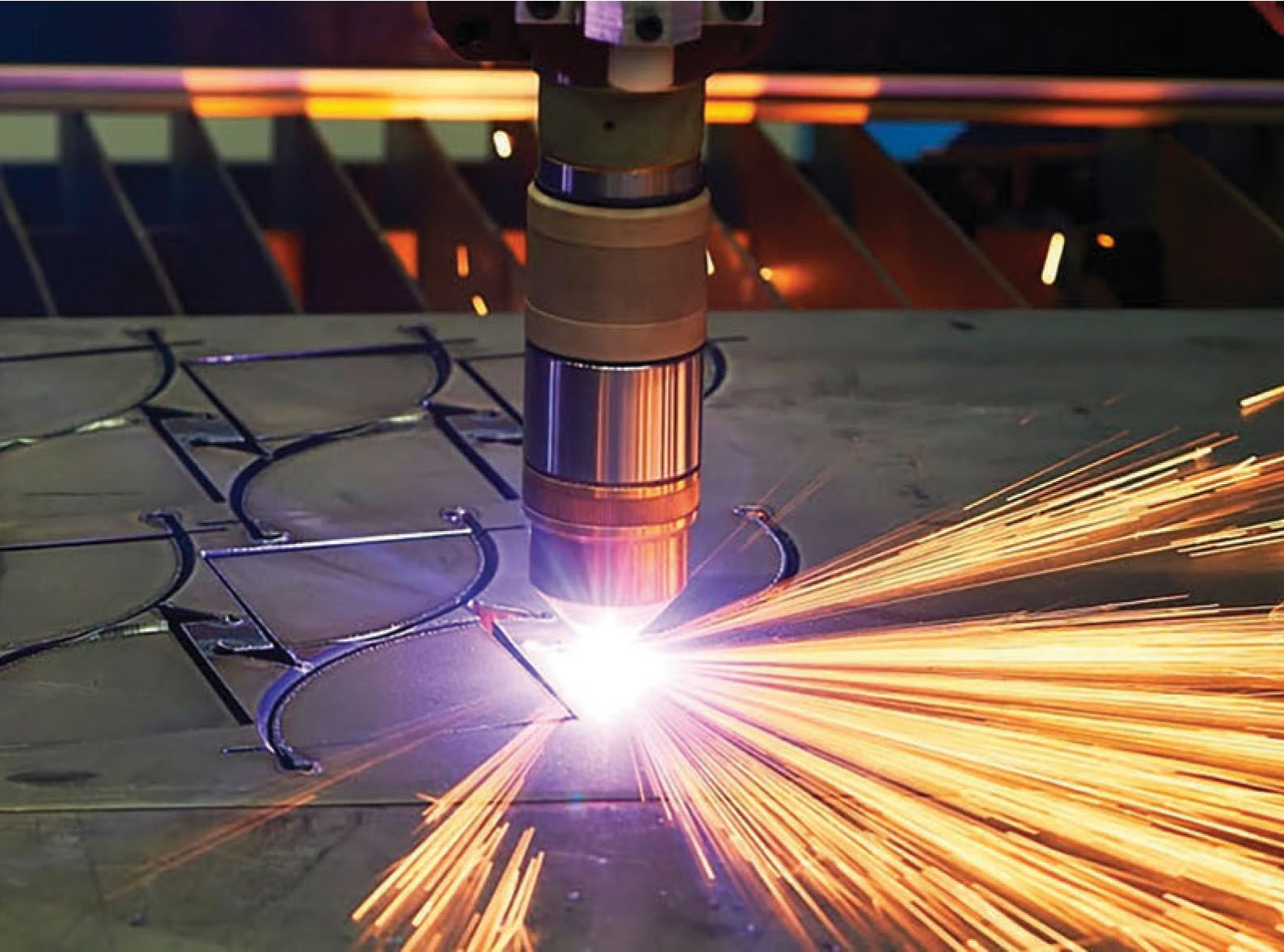

**PLASMA ARC CUTTING** IS CARRIED OUT BY A STREAM OF COMPRESSED AIR, WHICH TURNS INTO PLASMA UNDER THE ACTION OF AN ELECTRIC ARC. IN THIS PROCESS, THE PLASMA TEMPERATURE IS ABOUT 20,000 K, WHICH ALLOWS TO CUT SHEET BLANKS FROM METAL EVEN OF LARGE THICKNESS.

"D&POS" PROVIDES SERVICES OF PLASMA ARC CUTTING. THE EQUIPMENT IS DESIGNED FOR CONTOUR CUTTING OF SHEET METAL WORKPIECES.

# ADVANTAGES OF PLASMA ARC CUTTING

- ◇ the lowest requirements for material properties and environmental conditions at the processing site;
- ◇ high speeds of plasma cutting of sheet metal of small and medium thickness (in comparison with autogenous cutting, the excess speed can be 10-fold);
- ◇ higher speeds of plasma cutting of materials of medium and large thickness than with laser cutting.

## TYPES OF RAW MATERIALS FOR PLASMA ARC CUTTING

Plasma arc cutting is possible for the majority of metals of various thickness. The most popular types of raw materials are steel, cast iron, copper, titanium, etc. The thickness of the cut directly depends on the thermal conductivity of the material, so the higher the thermal conductivity, the smaller the possible thickness of the sheet that can be cut.

## PRODUCTION CAPABILITIES

NAME	SPECIFICATIONS
Construction steel	From 1 to 60 mm
Maximum dimensions of the workpiece	2 000 x 6 000 mm
Maximum weight of the workpiece	9 420 kg
Maximum speed of movement of the plasma head	Up to 16 m/min
Maximum speed of cut	8 m/min
Non-straightness	Not more than 1.25 mm per 1 000 mm
Deviation of linear dimensions	Up to 2 mm
Angle of cut (obliquity)	Up to 5 degrees depending on the thickness of the metal

## WE OFFER

- ◇ two units for plasma cutting;
- ◇ the ability to perform high-quality cutting of metal: low-carbon (ferrous metal) up to 40 mm with piercing and up to 60 mm with metal cutting from the edge;
- ◇ the maximum dimensions of the workpiece are 2000x6000 mm;
- ◇ high positioning accuracy +/- 0.2 mm;
- ◇ the possibility of curly cutting of mesh materials, gratings;
- ◇ high-quality bolt holes;
- ◇ high efficiency.



# SHEET PUNCHING

"D&POS" provides services for cutting a sheet on a coordinate-punching press according to individual parameters. It is possible to perform a full cycle of manufacturing metal products: sheet cutting, perforation, bending on a sheet-bending mill, powder painting or galvanizing of products.

Cutting on a coordinate-punching press is efficient when manufacturing:

- ◇ the same type of body parts;
- ◇ backplates;
- ◇ brackets and other products;
- ◇ household appliances;
- ◇ automobile construction;
- ◇ large-scale production, etc.

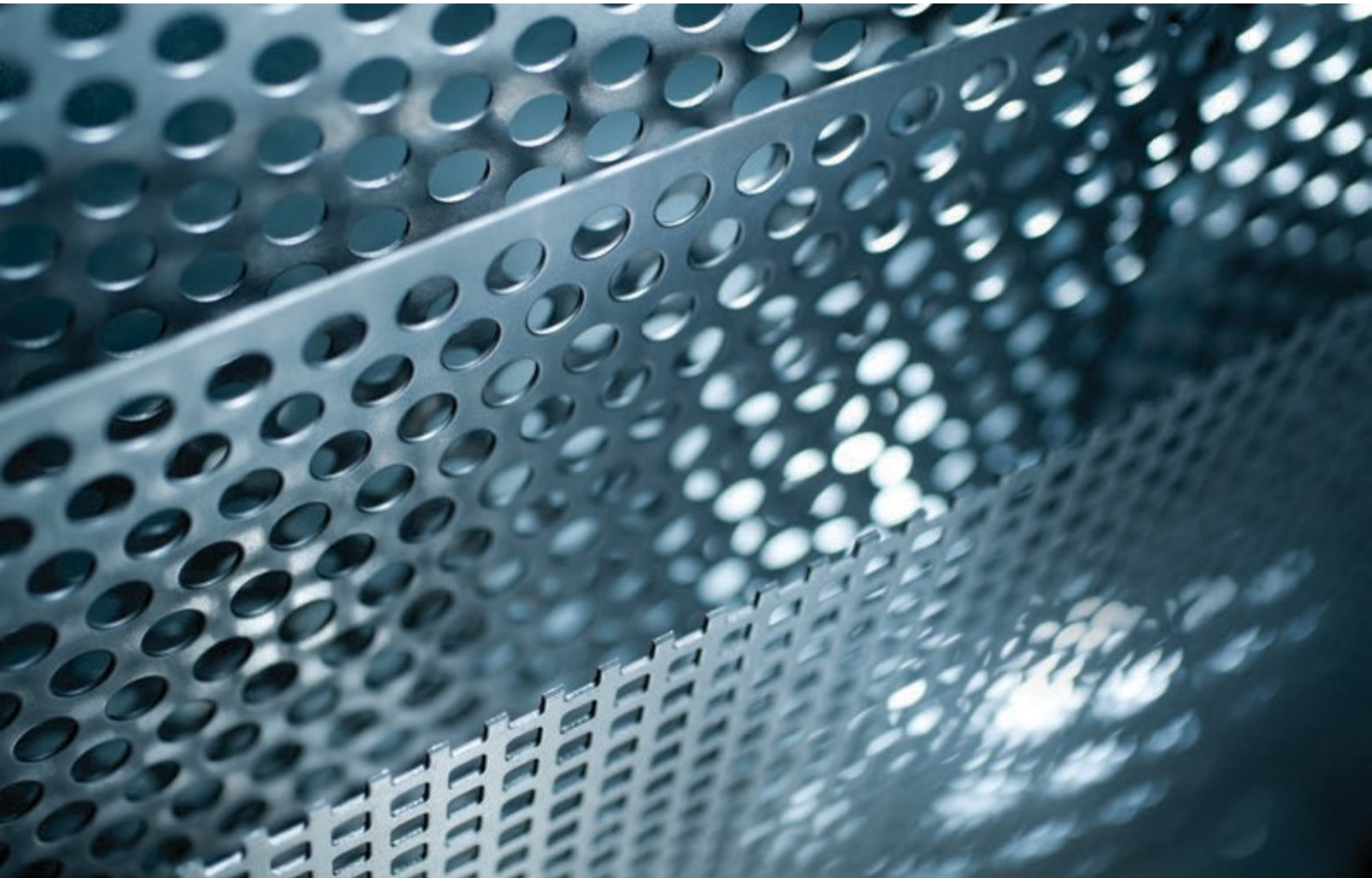

**PERFORATED METAL SHEET** - IS A THIN METAL SHEET WITH SMALL HOLES DIFFERENT IN SIZE, SHAPE, STRAIGHT OR OFFSETED ORDER OF APPLICATION. IT IS A MODERN STRUCTURAL AND FINISHING MATERIAL THAT HAS A WHOLE SET OF UNIQUE PROPERTIES.

Making holes in a sheet of metal and shaping the contour of a part on a punching press is performed by a series of hits of the punching tool on the sheet, which moves on the coordinate table with the help of precise and fast clamps, which are subject to a computer program. In this case, the cutting is superior to the laser one in quality and accuracy.

We also perform decorative and artistic perforation of the sheet, we accept individual orders for non-standard perforation. It is possible to manufacture a perforated sheet.



## BASIC PROPERTIES OF A PERFORATED SHEET

- ◇ easy to cut and there are various shapes and configurations;
- ◇ extremely attractive in decorative terms due to the ability to create various patterns, sprays and textures on it;
- ◇ it weighs significantly less than a conventional metal sheet;
- ◇ it has high indicators of flexibility, strength and longevity, which makes it popular in construction;
- ◇ it is easy to install and does not require powerful load-bearing elements.

## PRODUCTION CAPABILITIES

NAME	SPECIFICATIONS
Maximum dimensions of the sheet	3 000 x 1 500 mm
Maximum weight of the sheet	250 kg
Thickness of the sheet	From 0.5 to 3 mm



# SCOPE OF APPLICATION

Perforated metal sheet due to its unique properties and a large number of manufacturing options (pattern, size, thickness, material, etc.) has a very wide application in various areas of the national economy. It is very popular in construction and design.

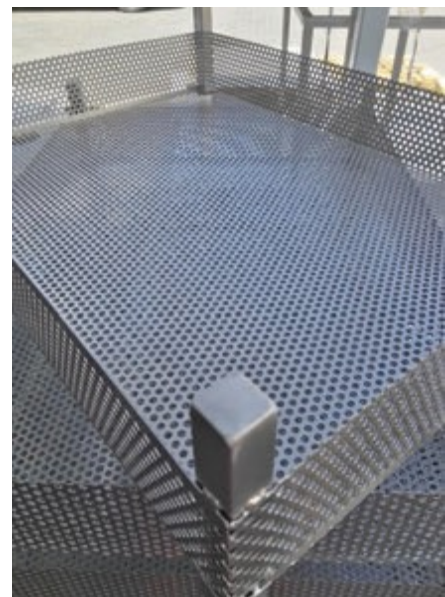
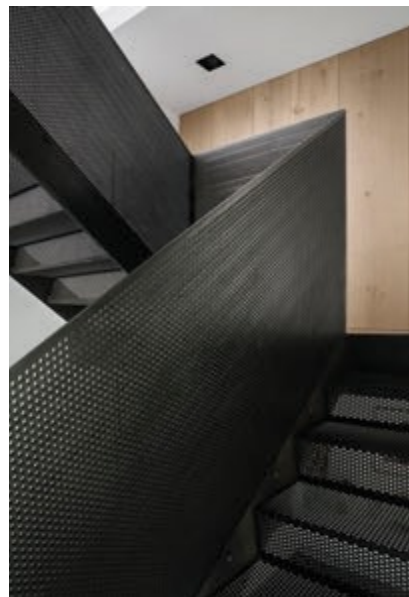
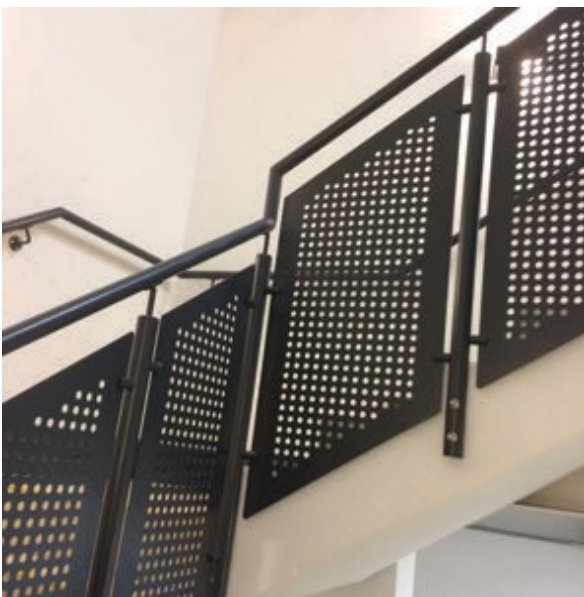

# ADVANTAGES OF WORKING WITH "D&POS"

The perforated sheets produced by the group of companies "D&POS" on a modern Italian coordinate-punching press meet the high requirements of domestic and foreign standards;

- ◇ the possibility of manufacturing samples from 1 mm;
- ◇ manufacturing of perforated sheets of any length (up to 3 000 mm) and width (up to 1 500 mm);
- ◇ waste-free production (we cut the rolls to the desired size).

## TYPES OF PERFORATED METAL SHEETS

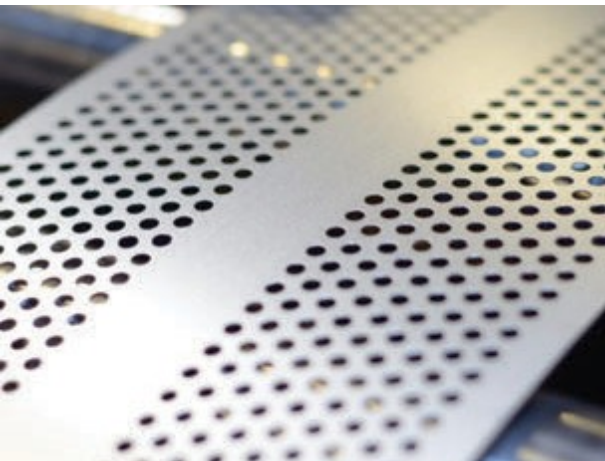

Perforated metal sheets differ from each other in a number of parameters that can solve completely different tasks. One of the most important variables here is the material from which the sheet is made: various ferrous or non-ferrous metals act as it.

**STAINLESS ALLOY STEEL** (GOST 5582; GOST 5632; EN 10088-1) — austenitic (12x17 – AISI 430) or ferritic (8x18H 10 – AISI 304) class.

These are the most durable steel grades from which the perforated sheet is made, they are easy to weld, show high corrosion resistance characteristics in aggressive environments. Stainless steel is most often used in food, textile, chemical, nuclear, oil and gas and other industries. The ferritic class is usually used in the food and chemical industry due to its resistance to oxidizing environments, the austenitic class is used in mechanical engineering because of its resistance to sulfur-containing media and sudden temperature changes.



**COLD-ROLLED CARBON STEEL** (GOST 16523; GOST 19904).

Sheets up to 2 mm thick are made of it. In the manufacture of products, powder spraying is often used to prevent corrosion. Most often, perforated sheets from this steel grade are used to decorate rooms.

**HOT-ROLLED CARBON STEEL** (GOST 19903).

This metal is used to create thicker perforated sheets that most often have technical application than a decorative one (for example, creation of bearing structures).

**GALVANIZED STEEL** (GOST 21631; GOST 14918).

Its characteristic feature is high moisture and corrosion resistance, therefore it is often used as a facing material, as well as for creating various partitions during construction.

**ALUMINUM AND ALLOYS** (ГОСТ13726).

Sheets made of aluminium are the lightest and most flexible, so they are most often used for decorating rooms. However, it is important to remember, that aluminium fades quickly in the open air.



# METAL FORMING

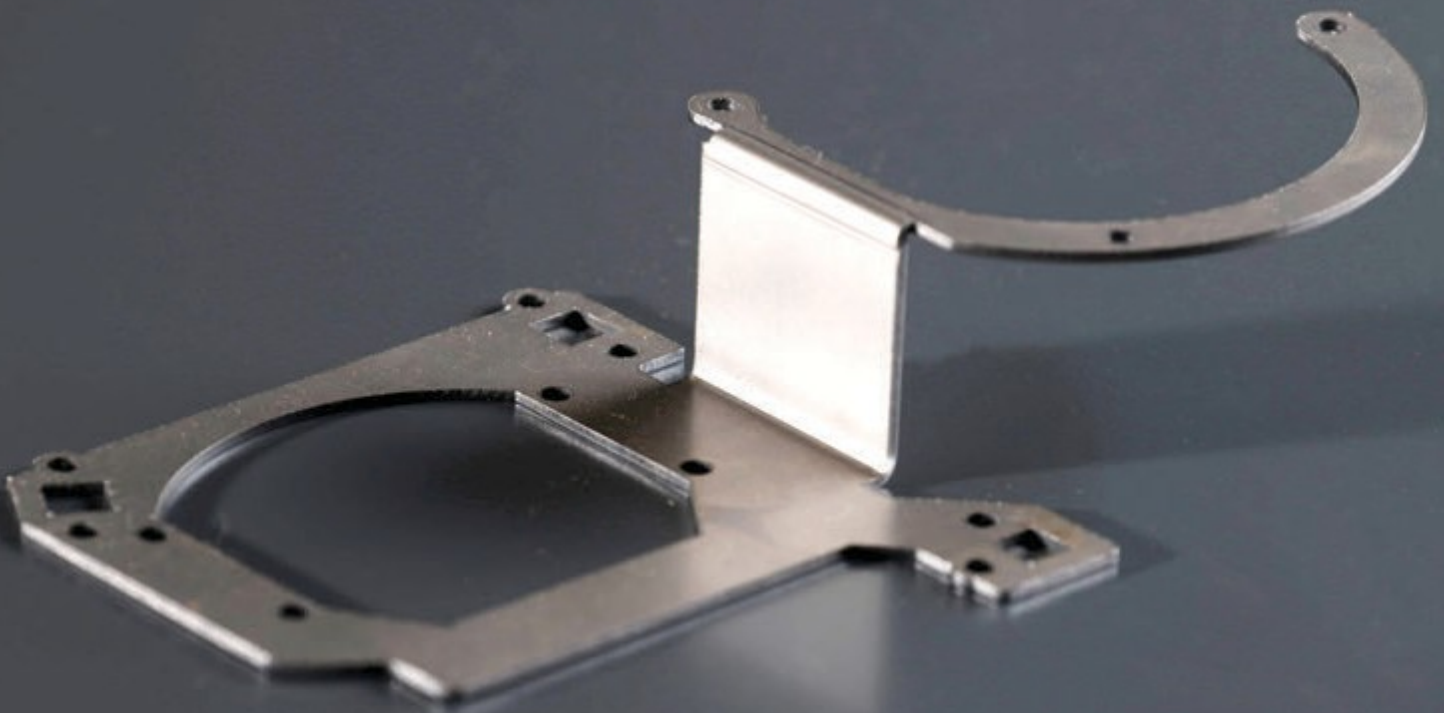

"D&POS" PROVIDES SERVICES FOR **FORMING OF METAL WORKPIECES** FOR THEIR SUBSEQUENT PROCESSING. THE PROCESS OF FORMING IS COMPLETELY **AUTOMATIC** AND IS CARRIED OUT WITH THE HELP OF SPECIALIZED **FORMING MACHINES** THAT ALLOW TO ENSURE **AHIGH QUALITY** OF WORK.

METAL WORKPIECES CREATED BY FORMING HAVE A WIDE RANGE OF APPLICATIONS.

# ADVANTAGES OF METAL FORMING

- ◇ high forming accuracy ensures stability and high repeatability of bent corners, which is especially important for further operations on parts: welding, assembly, painting, as well as their further operation;
- ◇ the result of forming is a monolithic construction of a seamless type;
- ◇ saving material, since the process is almost waste-free;
- ◇ maintaining the mechanical strength of the product due to the absence of welds or other joints;
- ◇ anti-corrosion resistance, which is ensured by the fact that during the deformation of the workpiece there is no significant change in the structure of the metal compared to welding;
- ◇ attractive appearance of the product.



## PRODUCTION CAPABILITIES

Our equipment allows to carry out metal forming with a thickness from 0.4 to 12 mm with almost any possible bend radius. The maximum length of the bend is 3 meters.

High accuracy of metal forming gives stability and high repeatability of bent corners, which is especially important for further operations on parts, such as welding and assembly.

Raw material	Thickness
Construction steel	From 0.4 to 12 mm
Stainless steel	From 1 to 8 mm
Aluminium	From 0.5 to 5 mm
Brass	From 0.05 to 4 mm
Copper	From 0.5 to 2 mm
Maximum dimensions of the workpiece	1 500 x 3 000 mm





# ENGINEERING CENTER



SINCE 2017, VERKHNEVOLZHSKY SMC HAS ITS OWN **ENGINEERING CENTER**. IT ALLOWS TO FLEXIBLY RESPOND TO THE NEEDS OF OUR PRODUCTION AND CUSTOMERS, TO PROVIDE THE NECESSARY EQUIPMENT AND TOOLS.

The installed technological equipment from Russian and foreign manufacturers makes it possible to design, manufacture and service various types of tools:

- ◇ **FORMING** — rolls, matrices and punches;
- ◇ **CHIPPING** — knives for guillotine, for the manufacture of expanded steel sheet;
- ◇ **CUTTING** — knives for slitting rolled metal;
- ◇ **MOLDS.**

Moreover, the specialists of the engineering center are engaged in the design of new and modernization of existing equipment, improvement of their technological capabilities, quality control of order fulfillment at all stages of production.

## ADVANTAGES OF WORKING WITH US

- ◇ short terms of order execution;
- ◇ raw materials from large metallurgical plants;
- ◇ equipment from the best domestic and international brands;
- ◇ manufacturing of parts exactly according to the specified parameters;
- ◇ localization of the full production cycle in one place: from design to manufacture of finished products;
- ◇ quality control at all stages of manufacture.





# DELIVERY

"D&POS"'S VEHICLE FLEET CONSISTS OF MORE THAN **100 SCANIA HEAVY TRUCKS**. EACH TRUCK IS EQUIPPED WITH **THE SYSTEM OF MOBILE POSITIONING** THAT OPERATES ON THE LBS PRINCIPLE (LOCATION — BASED SERVICE), WHICH ALLOWS TO **CONTROL** THE LOCATION ON THE WAY AND THE TIME OF DELIVERY OF METAL PRODUCTS.





"D&POS" offers to its clients a full range of additional services, delivery of the metal products included.

Our specialists are ready to take on all the complexities of transport logistics and choose a solution that fully meets the needs and tasks of customers.

Delivery is carried out to all regions of Russia and to the CIS countries. We offer the shipment of products by our own cars or by rail.

For the delivery of products by rail, we carry out the assembly of prefabricated wagons. At the request of the client, direct deliveries from metallurgical plants are possible.

We offer a variety of schemes of packaging depending on the type of metal products, the delivery region and the storage method. Our managers always offer the best options based on their work experience.





# SCRAP RECYCLING

Industry plays a very important role in our lives. Most of the metal products that we use in our everyday life, as well as almost all the metal products used by us in production, are manufactured by domestic metallurgical enterprises.

The resources of metal ore deposits belong to the strategic resources of the country, their expenditure is a factor that actually weakens the potential of Russia. Also in the future, the depletion of these resources is foreseen - and thus a significant drop in economic returns from the sphere of metal processing and metal production.



AT THE MOMENT, **THE IMPORTANCE OF RECEIVING, COLLECTING AND PROCESSING SCRAP METAL** LIES IN TWO ASPECTS:

**FIRSTLY**, BY DOING THIS, WE HELP **TO SAVE THE RESOURCES** OF THE DEPOSITS (AS WELL AS THE RESOURCES OF FUEL AND OTHER MATERIALS USED FOR THE EXTRACTION OF METAL-CONTAINING ORE).

**SECONDLY**, THE COST OF METAL PROCESSING IS OFTEN SIGNIFICANTLY **LOWER THAN THE COST** OF OBTAINING IT.

After all, in order to extract one ton of metal from ore, it is necessary to develop a deposit, and then convert the ore into metal. All this causes huge consumption of fuel and other materials, as well as indirect losses - wear and tear of equipment, wages and much more.

The developed deposits are the cause of many environmental problems - starting from the waterlogging of the area near the quarry and ending with environmental pollution from production waste and ore processing.

Some of the most environmentally unfriendly enterprises are metallurgical ones. For a long time, our country has been looking for ways to reduce their impact on the environment and there are various programs for restoring nature.

THE REUSE OF SCRAP METAL CAN SIGNIFICANTLY **REDUCE THE BURDEN ON THE ENVIRONMENT** AND SAVE A LOT OF NATURAL RESOURCES. THE MORE EFFICIENT THE COLLECTION OF SCRAP METAL IS, THE **CLEANER AND SAFER** THE NATURE OF OUR COUNTRY REMAINS.

"D&POS" USES METAL PRODUCTS **ONLY FROM DOMESTIC** METALLURGICAL ENTERPRISES IN THE MANUFACTURE OF ITS PRODUCTS.





# OUR PROJECTS

The group of companies "D&POS" took part in construction of significant facilities throughout Russia:

- ◇ Crimean Bridge, Kerch Strait
- ◇ New Karamyshevsky bridge, Moscow
- ◇ Sheremetyevo Airport, Khimki, Moscow Region
- ◇ Domodedovo Airport, Domodedovo, Moscow Region
- ◇ Cathedral of Christ the Savior, Moscow
- ◇ Church of the Resurrection of Christ, or the Main Church of the Armed Forces of the Russian Federation, Odintsovo District, Moscow Region
- ◇ "SK Polevo" Stadium , Istra
- ◇ Moscow International Business Center "Moscow-City", Moscow
- ◇ Construction of many transport interchanges on federal highways of Russia
- ◇ Eastern North-Urengoysoye field, Yamalo-Nenets Autonomous District
- ◇ Construction of a large boiler with a steam turbine at the pulp and paper mill of JSC "Mondi Syktyvkar-Kara LPC", Syktyvkar, Komi Republic
- ◇ Branch of Inter RAO - Engineering, Kaliningrad
- ◇ Pregolskaya TPP, Kaliningrad region
- ◇ Elevator complex for the acceptance, cleaning and drying of grain crops, Kursk region
- ◇ Modernization of the steam-power industry, Orel
- ◇ Technological facilities at Gazpromneft-ONPZ JSC, Omsk
- ◇ CS "Slavyanskaya", Leningrad region





- ◇ PJSC "Metafax", Perm Krai
- ◇ Primorskaya TPP, Kaliningrad region
- ◇ Nizhneartovsk Electric networks, JSC TyumenEnergO, Khanty-Mansi Autonomous Okrug
- ◇ Novovoronezh NPP, Voronezh Region
- ◇ West-Siberian complex of processing of hydrocarbon raw materials, Tobolsk, Tyumen region
- ◇ Construction of the sludge treatment department in the shop of neutralization and treatment of industrial wastewater "Sibur-Tobolsk", Tobolsk, Tyumen region
- ◇ Amur Gas Processing Plant, Amur region
- ◇ Taman bulk cargo terminal, Temryuksky district, Krasnodar Krai
- ◇ Terminal in the port of Taman, Temryuksky district, Krasnodar Krai
- ◇ Pharmaceuticals plant KRKA-Rus, Istra, Moscow region
- ◇ Plant for the production of pumps Grundfos, Istra, Moscow region
- ◇ Mercedes-Benz Manufacturing Rus plant, Moscow region
- ◇ Car factories Volkswagen, Volvo, Peugeot, Kaluga
- ◇ Oriflame plant, Stupino, Moscow region
- ◇ Pressing plant, Kaluga
- ◇ Factory of household appliances "BEKO", Kirzhach, Vladimir region
- ◇ Mars factories, Stupino, Moscow region
- ◇ Pepsi plant, Moscow region
- ◇ Electrometallurgical plant, Vorsino settlement, Kaluga region
- ◇ Hypermarkets "Hyperglobus", "AUCHAN", "ATAK", "Metro Cash & Carry", "Leroy Merlin" in Moscow and the Moscow region
- ◇ Zhemchuzhnaya Plaza Shopping Center, Saint Petersburg
- ◇ All-Russian Academy of Foreign Trade of the Ministry of Economic Development of the Russian Federation, Moscow
- ◇ Educational and Scientific Center named after Peter the Great, Balashikha, Moscow region





# CONTACTS



ROLLED METAL ♦ PRODUCTION ♦ SERVICE

**[www.dipos.ru](http://www.dipos.ru)**